

# FAX System 12 Operation Guide



---

# Contents

Contents .....	i
Preface .....	vi
About the FAX Operation Guide (this Guide) .....	vi
Structure of the guide .....	vi
Conventions Used in This Guide .....	vii

## **1 Legal and Safety Information ..... 1-1**

Notice .....	1-2
Safety Conventions in This Guide .....	1-2
About this Operation Guide .....	1-3
Legal Notice .....	1-3
FCC PART 68 REQUIREMENTS .....	1-3
IMPORTANT SAFETY INSTRUCTIONS .....	1-4
IMPORTANTES MESURES DE SECURITE .....	1-4
CANADIAN IC REQUIREMENTS .....	1-5
CONDITIONS DE L'IC CANADIENNE .....	1-5
Technical regulations for terminal equipment .....	1-6
Network Compatibility Declaration .....	1-6
Trademark Information .....	1-6

## **2 Before Using the Fax Machine ..... 2-1**

Part Names and Functions .....	2-2
Machine .....	2-2
Operation Panel .....	2-4
Touch Panel .....	2-5
Previewing Images .....	2-7
Entering Numbers .....	2-10
Using the Enter Key .....	2-11
Using the Quick No. Search Key .....	2-11
Quick Setup Wizard .....	2-12
Fax setup items .....	2-12
Power Off setup items .....	2-13
Fax and Power Off setup procedure .....	2-14
Setting Date and Time .....	2-15
Registering Destinations in the Address Book .....	2-16
Adding a Destination (Address Book) .....	2-16
Adding a Destination on One Touch Key .....	2-25
Quick Setup Screen .....	2-28
Functions Available for Registration in the Quick Setup Screen .....	2-28
Changing Registration .....	2-29
Registering Shortcuts .....	2-30
Adding Shortcuts .....	2-30
Editing Shortcuts .....	2-31
Deleting Shortcuts .....	2-31

## **3 Sending Faxes ..... 3-1**

Basic transmission procedure .....	3-2
Using redial .....	3-3
Checking the Send Status .....	3-4
Priority Override Send .....	3-4
Cancelling Memory Transmission (while originals are being scanned) .....	3-5
Cancelling Memory Transmission (during communication) .....	3-5
Cancelling Transmission (Disconnection of Communication) .....	3-6
Methods For Entering the Destination .....	3-7
Entering the destination fax number with the numeric keys .....	3-7

Choosing from the Address Book .....	3-9
Choosing from the One Touch Key .....	3-11
Choosing from the Speed Dial .....	3-11
Choosing from the Destination History .....	3-12
Checking and Editing Destinations .....	3-13
Broadcast Transmission .....	3-14
Login/Logout .....	3-17
Logging in when User Login Administration has been Enabled .....	3-17
Logging in when Job Accounting has been Enabled .....	3-18
Fax transmission functions .....	3-19
Original Size .....	3-21
Mixed Size Originals .....	3-21
2-sided/Book Original .....	3-22
Original Orientation .....	3-22
Sending Size .....	3-23
Long Original .....	3-23
Density .....	3-23
Original Image .....	3-23
FAX TX Resolution .....	3-24
Zoom .....	3-24
Centering .....	3-24
Border Erase/Full Scan .....	3-25
FAX Delayed Transmission .....	3-26
Setting the Delayed Transmission .....	3-27
Changing/Deleting Delayed Transmission .....	3-27
Cancelling Delayed Transmissions (Queued) .....	3-28
Immediate transmission .....	3-28
Continuous Scan .....	3-28
Job Finish Notice .....	3-28
File Name Entry .....	3-29
FAX Direct Transmission .....	3-29
Cancelling Direct Transmission .....	3-29
Send and Print .....	3-30
Send and Store .....	3-30
FAX TX Report .....	3-30
Manual Send .....	3-31
Standby Transmission .....	3-32
Interrupt Send .....	3-33
Using chain dial .....	3-34
Using Program .....	3-36

## **4 Receiving Faxes ..... 4-1**

FAX Reception .....	4-2
Reception Method .....	4-2
Set the Reception Method .....	4-2
Automatic Reception .....	4-3
Flow of automatic reception .....	4-3
Canceling reception (Disconnection of communication) .....	4-3
Manual Reception .....	4-4
Flow of manual reception .....	4-4
Fax reception functions .....	4-5
Media Type for Print Output .....	4-6
FAX Exclusive Paper Source .....	4-7
Multipurpose Tray .....	4-7
Reduced RX Size .....	4-7
Reception Date/Time .....	4-8
Duplex Printing .....	4-8
2 in 1 Print .....	4-8

## 5 Using Convenient Fax Functions ..... 5-1

Memory Forwarding .....	5-2
Type of Forwarding Destination and Requirements for Forwarding .....	5-2
Forward Settings .....	5-4
Forward all received documents (Use Rule for All Receptions) .....	5-4
Forward only received documents that match the conditions (Use Rule for Specific RX) .....	5-6
Forward received documents that do not match the conditions .....	5-9
Cancelling Memory Forwarding .....	5-9
Changing/Deleting Requirements for Forwarding .....	5-10
Raising the Priority of Requirements for Forwarding .....	5-10
Cancelling the Setting of RX/Forward Rules .....	5-10
Forwarding Detail Settings .....	5-11
Forwarding Time Setting .....	5-11
File Format Setting .....	5-11
File Separation .....	5-12
E-mail Subject Add. Info. Setting .....	5-12
FTP Encrypted TX Setting .....	5-13
Print Setting .....	5-14
File Name Registration .....	5-15
Settings for Forwarding from Command Center RX (Forward Settings) .....	5-16
FAX Box Function .....	5-17
FAX Box .....	5-17
Sub Address Communication .....	5-17
Registering a FAX Box .....	5-18
Changing FAX Box .....	5-20
Deleting FAX Box .....	5-20
Printing Originals from a FAX Box .....	5-21
Checking Details .....	5-22
Previewing Images .....	5-22
Deleting Originals after Printing from a FAX Box .....	5-23
Deleting Originals from a FAX Box .....	5-23
Printing a FAX Box List .....	5-24
Sub Address Transmission .....	5-25
Sub Address Reception .....	5-26
Polling Communication .....	5-28
Polling Transmission .....	5-28
Polling Reception .....	5-31
Printing from a Polling Box .....	5-33
Checking Details .....	5-34
Deleting Originals in a Polling Box .....	5-34
FAX Memory RX Box .....	5-35
How to print from the FAX Memory RX Box .....	5-35
How to delete a fax from the FAX Memory RX Box .....	5-36
Encryption .....	5-37
Registering an Encryption Key .....	5-38
Changing Registration Contents of Encryption Key .....	5-38
Deleting Registration Contents of Encryption Key .....	5-39
Using the Encrypted Transmission .....	5-39
Setting the Encrypted Reception .....	5-40
Using a Connected Telephone .....	5-41
FAX/TEL Auto Switch Reception .....	5-41
FAX/Answering Machine Auto Switch Reception .....	5-43
DRD Reception (Available for some countries.) .....	5-45
Manual Send .....	5-47
Manual Reception .....	5-48
Remote Switch Function .....	5-49

<b>6</b>	<b>Sending Faxes from PC .....</b>	<b>6-1</b>
	Flow of Network FAX Sending .....	6-2
	Flow of Network FAX Receiving .....	6-2
	Setup .....	6-3
	Installing the FAX Driver .....	6-4
	Uninstalling the FAX Driver .....	6-6
	Basic Transmission .....	6-7
	Configuring the Driver Default Settings .....	6-10
	Default Settings Dialog Box .....	6-11
	Changing Transmit Settings .....	6-15
	Using Cover Pages .....	6-20
	Cover Page Registration (Default Settings) .....	6-26
	Transmission Control .....	6-32
<b>7</b>	<b>Managing Jobs .....</b>	<b>7-1</b>
	Various Tools for Checking Transmission Results and Registration Status .....	7-2
	Checking FAX Job History .....	7-3
	Displaying Job Log Screen .....	7-3
	Description of the Job Log Screen .....	7-4
	Checking Details of the Job Log .....	7-5
	Printing Administrative Reports (Result Report Setting) .....	7-7
	Send Result Reports .....	7-7
	Attach Image of NW FAX .....	7-8
	Report for Job Canceled before Sending .....	7-8
	Recipient Format .....	7-8
	FAX RX Result Reports .....	7-9
	Activity Report (Outgoing FAX Report and Incoming FAX Report) .....	7-10
	Printing Activity Reports .....	7-10
	Automatic Printout .....	7-10
	Status Page .....	7-11
	Reporting FAX Receipt Result by E-mail .....	7-12
	Confirmation Screen of Destinations .....	7-13
<b>8</b>	<b>Fax Settings .....</b>	<b>8-1</b>
	Default fax settings .....	8-2
	Operation method .....	8-2
	System Menu Settings .....	8-4
	Cassette/MP Tray Settings .....	8-5
	Common Settings .....	8-6
	Document Box/USB Drive .....	8-9
	FAX .....	8-9
	Report .....	8-15
	Adjustment/Maintenance .....	8-15
	Transmission Restriction .....	8-16
	Registering Permit FAX No. ....	8-17
	Changing Permit FAX No. ....	8-18
	Deleting Permit FAX No. ....	8-18
	Registering Reject FAX No. ....	8-19
	Changing Reject FAX No. ....	8-19
	Deleting Reject FAX No. ....	8-20
	Registering Permit ID No. ....	8-20
	Changing Permit ID No. ....	8-21
	Deleting Permit ID No. ....	8-21
	Setting Send Restriction .....	8-22
	Setting Reception Restriction .....	8-22
	Unknown Number Reception .....	8-23
	Unusable Time .....	8-24
	Account Management .....	8-26

<b>9</b>	<b>Optional Equipment .....</b>	<b>9-1</b>
	Internet FAX Kit(A) "Internet FAX Kit" .....	9-2
	Dual FAX .....	9-3
	Dual FAX Settings .....	9-3
	Reception Port Selection .....	9-3
	Job Accounting Port Restrictions .....	9-4
<b>10</b>	<b>Internet Faxing (i-FAX) .....</b>	<b>10-1</b>
	What is i-FAX? .....	10-2
	i-FAX Settings .....	10-5
	Accessing Command Center RX .....	10-5
	i-FAX Default Settings .....	10-6
	i-FAX transmission procedure .....	10-10
	Checking the Send Status .....	10-12
	i-FAX Reception .....	10-13
<b>11</b>	<b>Troubleshooting .....</b>	<b>11-1</b>
	Indicators During Sending/Receiving Operation .....	11-2
	Responding to an Attention Indicator Flashes .....	11-2
	Precautions When Turning Power OFF .....	11-3
	Messages .....	11-4
	Error Code List .....	11-6
	Troubleshooting .....	11-10
	Common inquiries .....	11-13
<b>12</b>	<b>Appendix .....</b>	<b>12-1</b>
	Character Entry Method .....	12-2
	Entry Screens .....	12-2
	Entering Characters .....	12-4
	Specifications .....	12-5
	Menu Map .....	12-7
	Received FAX Sizes and Paper Priority (Metric Model) .....	12-13
	Received FAX Sizes and Paper Priority (Inch Model) .....	12-17
	Index .....	Index-1

---

# Preface

This Operation Guide is intended to help you operate the machine correctly, perform routine maintenance and take a simple troubleshooting action as necessary, so that you can always use the machine in good condition.

Please read the Operation Guide before using the facsimile. Keep it close to the facsimile for easy reference.

## About the FAX Operation Guide (this Guide)

### Structure of the guide

This Operation Guide contains the following chapters.

Chapter		Contents
1	Legal and Safety Information	Provides precautions regarding use of the machine and trademark information.
2	Before Using the Fax Machine	Explains the part names and the quick setup wizard.
3	Sending Faxes	Explains the general methods for sending faxes and transmission functions.
4	Receiving Faxes	Explains the general methods for receiving faxes and reception functions.
5	Using Convenient Fax Functions	Explains convenient fax functions such as storing received faxes in boxes in the memory, forwarding received faxes, and polling communication (a function that allows the receiving party to call and initiate fax reception).
6	Sending Faxes from PC	Explains how to send a FAX from a PC.
7	Managing Jobs	Explains how to check the status of recently performed transmission and reception operations in the touch panel. Also explains how to print administrative reports showing communication results, machine settings, and registered information.
8	Fax Settings	Explains various settings for controlling fax usage, such as restricting transmission destinations, blocking fax reception, and setting prohibited use times.
9	Optional Equipment	Introduces the optional Internet FAX Kit and Dual FAX and explains how to use the machine when optional features are installed.
10	Internet Faxing (i-FAX)	Explains how to use the i-FAX function and the settings required for Internet faxing. * Please substitute Internet Faxing for i-FAX.
11	Troubleshooting	Explains what to do when errors are displayed or other problems occur.
12	Appendix	Explains how to enter characters, and lists the fax specifications.

# Conventions Used in This Guide

Adobe Reader XI is used as an example in the explanations below.

Click an item in the Table of Contents to jump to the corresponding page.

Click to move from the current page to the previously displayed page. This is convenient when you want to return to the page from which you jumped to the current page.

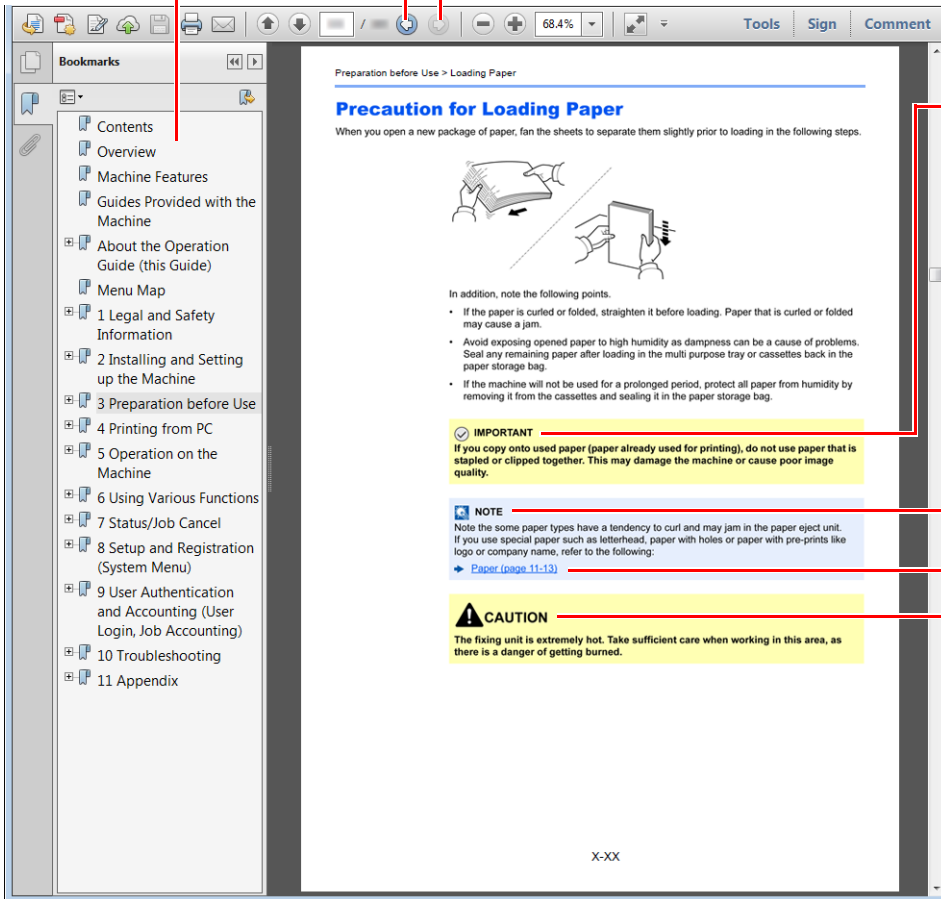

## IMPORTANT

Indicates operational requirements and restrictions to operate the machine correctly, and avoid damage to the machine or property.

## NOTE

Indicates supplemental explanations and reference information for operations.

## Refer to

Click the underlined text to jump to the corresponding page.

## CAUTION

Indicates that personal injury or mechanical damage may result from insufficient attention to or incorrect compliance with the related points.

## NOTE

The items that appear in Adobe Reader vary depending on how it is used. If the Table of Contents or tools do not appear, refer to Adobe Reader Help.

Certain items are indicated in this guide by the conventions described below.

Convention	Description
[ <b>Bold</b> ]	Indicates keys and buttons.
"Regular"	Indicates a message or setting.







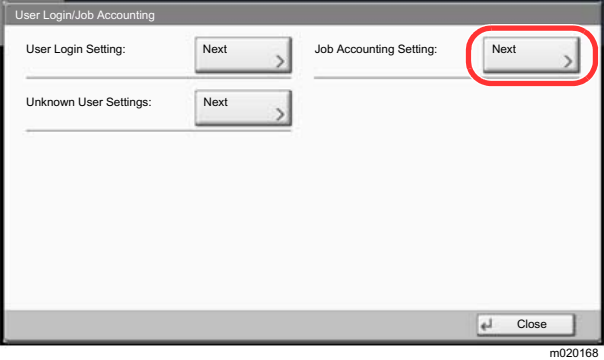
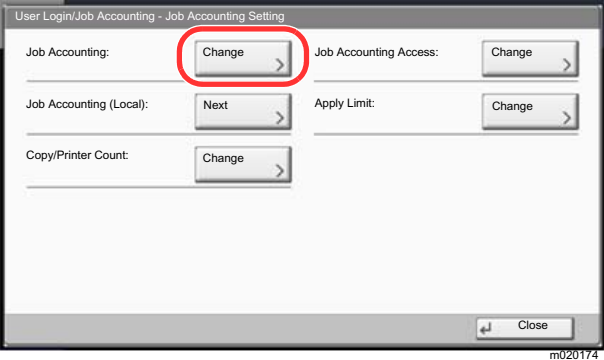

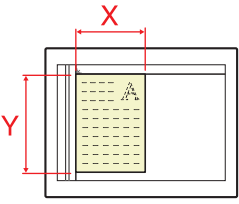

## Conventions used in procedures for operating the machine

In this Operation Guide, continuous operation of the keys on the touch panel is as follows:

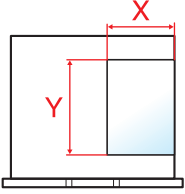
Actual procedure	Procedure indicated in this guide
<p>Select the [<b>System Menu/Counter</b>] key.</p> <p>▼</p> <p>Select [<b>∨</b>].</p> <p>▼</p> <p>Select [<b>Common Settings</b>].</p> <p>▼</p> <p>Select [<b>Sound</b>].</p>	<p>[<b>System Menu/Counter</b>] key &gt; [<b>Common Settings</b>] &gt; [<b>Sound</b>]</p>
<p>Select [<b>Next</b>] of "Job Accounting Settings".</p>  <p>▼</p> <p>Select [<b>Change</b>] of "Job Accounting".</p> 	<p>"Job Accounting Settings" [<b>Next</b>] &gt; "Job Accounting" [<b>Change</b>]</p>

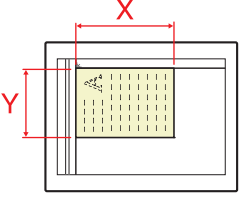
## Size and Orientation of Originals and Paper

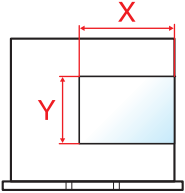
Original sizes and paper sizes such as A4, B5, and Letter can be used in both the horizontal and vertical orientations. To distinguish the orientations when these sizes are used, "R" is added to sizes used in the horizontal orientation. In addition, the following icons are used to indicate original and paper placement orientations on the touch panel.

Orientation		Setting Position (X=Length, Y=Width)	Icons on the touch panel	Indicated size in this Guide* <sup>1</sup>
Vertical orientation	Original	 Original	 Original	A4, B5, Letter .etc
	Paper	 Paper	 Paper	
Horizontal orientation (-R)	Original	 Original	 Original	A4-R, B5-R, Letter-R .etc
	Paper	 Paper	 Paper	

\*1 Original/paper sizes that can be used vary depending on the function and source tray. For details, refer to the following.

➔ *Machine's Operation Guide*

# 1 Legal and Safety Information



Please read this information before using your machine. This chapter provides information on the following topics.

Notice .....	1-2
Safety Conventions in This Guide .....	1-2
About this Operation Guide .....	1-3
Legal Notice .....	1-3
FCC PART 68 REQUIREMENTS .....	1-3
IMPORTANT SAFETY INSTRUCTIONS .....	1-4
IMPORTANTES MESURES DE SECURITE .....	1-4
CANADIAN IC REQUIREMENTS .....	1-5
CONDITIONS DE L'IC CANADIENNE .....	1-5
Technical regulations for terminal equipment .....	1-6
Network Compatibility Declaration .....	1-6
Trademark Information .....	1-6

# Notice



## Safety Conventions in This Guide

The sections of this handbook and parts of the facsimile marked with symbols are safety warnings meant to protect the user, other individuals and surrounding objects, and ensure correct and safe usage of the facsimile.



-  **WARNING:** Indicates that serious injury or even death may result from insufficient attention to or incorrect compliance with the related points.
-  **CAUTION:** Indicates that personal injury or mechanical damage may result from insufficient attention to or incorrect compliance with the related points.

### Symbols



The  symbol indicates that the related section includes safety warnings. Specific points of attention are indicated inside the symbol.

-  ... [General warning]
-  ... [Warning of high temperature]

The  symbol indicates that the related section includes information on prohibited actions. Specifics of the prohibited action are indicated inside the symbol.

-  ... [Warning of prohibited action]
-  ... [Disassembly prohibited]

The  symbol indicates that the related section includes information on actions which must be performed. Specifics of the required action are indicated inside the symbol.

-  ... [Alert of required action]
-  ... [Remove the power plug from the outlet]
-  ... [Always connect the machine to an outlet with a ground connection]

Please contact your service representative to order a replacement if the safety warnings in this Operation Guide are illegible or if the guide itself is missing (fee required).



#### NOTE

Due to performance updating, information in this Operation Guide is subject to change without notice.

## About this Operation Guide

This Operation Guide contains information on using the facsimile functions of this machine. Please read the Operation Guide before you start using the machine.

During use, refer to the Operation Guide for your machine for information regarding the sections listed below.

Environment
Precautions for Use
Loading Paper
Toner Container Replacement
Replace the Waste Toner Box
Cleaning
Solving Malfunctions
Responding to Messages
Clearing Paper Jams

## Legal Notice

WE SHALL HAVE NO LIABILITY FOR LOSS, WHETHER OR PARTIAL, OF RECEIVED DOCUMENTS WHEN SUCH LOSS IS CAUSED BY DAMAGES TO THE FAX SYSTEM, MALFUNCTIONS, MISUSE, OR EXTERNAL FACTORS SUCH AS POWER OUTAGES; OR FOR PURELY ECONOMIC LOSSES OR LOST PROFITS RESULTING FROM MISSED OPPORTUNITIES ATTRIBUTABLE TO MISSED CALLS OR RECORDED MESSAGES RESULTING THEREFROM.

## FCC PART 68 REQUIREMENTS

- 1 This equipment complies with Part 68 of the FCC rules and the requirements adopted by the ACTA. On the right side of the equipment to install Assembly Board is a label that contains, among other information, a product identifier in the format US:AAAEQ##TXXXX. If requested, this number must be provided to the telephone company.
- 2 This equipment connects to the network via USOC RJ11C.
- 3 A plug and jack used to connect this equipment to the premises wiring and telephone network must comply with the applicable FCC Part 68 rules and requirements adopted by the ACTA. A compliant telephone cord and modular plug is provided with this product. It is designed to be connected to a compatible modular jack that is also compliant. See installation instructions for details.
- 4 The REN is used to determine the number of devices that may be connected to a telephone line. Excessive RENs on a telephone line may result in the devices not ringing in response to an incoming call. In most but not all areas, the sum of RENs should not exceed five (5.0). To be certain of the number of devices that may be connected to a line, as determined by the total RENs, contact the local telephone company. For products approved after July 23, 2001, the REN for this product is part of the product identifier that has the format US:AAAEQ##TXXXX. The digits represented by ## are the REN without a decimal point (e.g., 03 is a REN of 0.3). For earlier products, the REN is separately shown on the label.
- 5 If this equipment causes harm to the telephone network, the telephone company will notify you in advance that temporary discontinuance of service may be required. But if advance notice isn't practical, the telephone company will notify the customer as soon as possible. Also, you will be advised of your right to file a complaint with the FCC if you believe it is necessary.
- 6 The telephone company may make changes in its facilities, equipment, operations or procedures that could affect the operation of the equipment. If this happens the telephone company will provide advance notice in order for you to make necessary modifications to maintain uninterrupted service.

- 7 If trouble is experienced with this equipment, please contact the following company for repair and (or) warranty information:

**KYOCERA Document Solutions America, Inc.**

225 Sand Road,  
Fairfield, New Jersey 07004-0008, USA  
Phone: +1-973-808-8444  
Fax: +1-973-882-6000

If the equipment is causing harm to the telephone network, the telephone company may request that you disconnect the equipment until the problem is resolved.

- 8 This equipment cannot be used on public coin service provided by the telephone company. Connection to Party line service is subject to state tariffs. Contact the state public utility commission, public service commission or corporation commission for information.
- 9 If your home has specially wired alarm equipment connected to the telephone line, ensure the installation of this equipment does not disable your alarm equipment. If you have questions about what will disable alarm equipment, consult your telephone company or a qualified installer.
- 10 The Telephone Consumer Protection Act of 1991 makes it unlawful for any person to use a computer or other electronic device, including FAX machines, to send any message unless such message clearly contains in a margin at the top or bottom of each transmitted page or on the first page of the transmission, the date and time it is sent and an identification of the business or other entity, or other individual sending the message and the telephone number of the sending machine or such business, other entity, or individual. (The telephone number provided may not be a 900 number or any other number for which charges exceed local or long-distance transmission charges.) In order to program this information into your FAX machine, you should complete the following steps: (Insure that it will be transmitted, see [Local FAX Name\(Port 1\) on page 2-12](#), [Local FAX Number\(Port 1\) on page 2-12](#), [TTI on page 2-12](#) and [Setting Date and Time on page 2-15](#).)

## IMPORTANT SAFETY INSTRUCTIONS

When using your telephone equipment, basic safety precautions should always be followed to reduce the risk of fire, electric shock and injury to persons, including the following:

**CAUTION:** To reduce the risk of fire, use only No.26 AWG or larger UL listed or CSA certified telecommunication line cord.

- 1 Do not use this product near water, for example, near a bath tub, wash bowl, kitchen sink or laundry tub, in a wet basement or near a swimming pool.
- 2 Avoid using a telephone (other than a cordless type) during an electrical storm. There may be a remote risk of electric shock from lightning.
- 3 Do not use the telephone to report a gas leak in the vicinity of the leak.
- 4 Use only the power cord and batteries indicated in this manual. Do not dispose of batteries in a fire. They may explode. Check with local codes for possible special disposal instructions.

## SAVE THESE INSTRUCTIONS

## IMPORTANTES MESURES DE SECURITE

Certaines mesures de sécurité doivent être prises pendant l'utilisation de matériel téléphonique afin de réduire les risques d'incendie, de choc électrique et de blessures. En voici quelques unes:

- 1 Ne pas utiliser l'appareil près de l'eau, p. ex., près d'une baignoire, d'un lavabo, d'un évier de cuisine, d'un bac à laver, dans un sous-sol humide ou près d'une piscine.
- 2 Eviter d'utiliser le téléphone (sauf s'il s'agit d'un appareil sans fil) pendant un orage électrique. Ceci peut présenter un risque de choc électrique causé par la foudre.
- 3 Ne pas utiliser l'appareil téléphonique pour signaler une fuite de gaz s'il est situé près de la fuite.
- 4 Utiliser seulement le cordon d'alimentation et le type de piles indiqués dans ce manuel. Ne pas jeter les piles dans le feu: elles peuvent exploser. Se conformer aux règlements pertinents quant à l'élimination des piles.

## CONSERVER CES INSTRUCTIONS

## CANADIAN IC REQUIREMENTS

"This product meets the applicable Innovation, Science and Economic Development Canada technical specifications."

"The Ringer Equivalence Number (REN) indicates the maximum number of devices allowed to be connected to a telephone interface. The termination on an interface may consist of any combination of devices subject only to the requirement that the sum of the RENs of all the devices not exceed five."

The REN (CANADA) of this product is 0.4.

## CONDITIONS DE L'IC CANADIENNE

"Le présent produit est conforme aux spécifications techniques applicables d'Innovation, Sciences et Développement économique Canada."

"L'indice d'équivalence de la sonnerie (IES) sert à indiquer le nombre maximal de dispositifs qui peuvent être raccordés à une interface téléphonique. La terminaison d'une interface peut consister en une combinaison quelconque de dispositifs, à la seule condition que la somme des IES de tous les dispositifs n'excède pas cinq."

Le IES (CANADA) pour ce produit est 0.4.

## Technical regulations for terminal equipment

Terminal Equipment (TE);TBR 21

Attachment requirements for pan-European approval for connection to the analogue Public Switched Telephone Networks (PSTNs) of TE (excluding TE supporting the voice telephony service) in which network addressing, if provided, is by means of Dual Tone Multi Frequency (DTMF) signalling.

This terminal equipment complies with:

- TBR21
- AN 01R00 AN for P
- AN 02R01 AN for CH and N
- AN 05R01 AN for D, E, GR, P and N
- AN 06R00 AN for D, GR and P
- AN 07R01 AN for D, E, P and N
- AN 09R00 AN for D
- AN 10R00 AN for D
- AN 11R00 AN for P
- AN 12R00 AN for E
- AN 16R00 General Advisory Note
- DE 03R00 National AN for D
- DE 04R00 National AN for D
- DE 05R00 National AN for D
- DE 08R00 National AN for D
- DE 09R00 National AN for D
- DE 12R00 National AN for D
- DE 14R00 National AN for D
- ES 01R01 National AN for E
- GR 01R00 National AN for GR
- GR 03R00 National AN for GR
- GR 04R00 National AN for GR
- NO 01R00 National AN for N
- NO 02R00 National AN for N
- P 03R00 National AN for P
- P 08R00 National AN for P

## Network Compatibility Declaration

The manufacturer declares that the equipment has been designed to operate in the public switched telephone networks (PSTN) in the following countries:

- Austria
- Belgium
- Bulgaria
- Cyprus
- Czech
- Denmark
- Estonia
- Finland
- France
- Germany
- Greece
- Hungary
- Iceland
- Ireland
- Italy
- Latvia
- Liechtenstein
- Lithuania
- Luxembourg
- Malta
- Norway
- Poland
- Portugal
- Romania
- Slovakia
- Slovenia
- Spain
- Sweden
- Switzerland
- The Netherlands
- United Kingdom

## Trademark Information

- Microsoft, Windows, Windows Server, Internet Explorer, Excel and PowerPoint are registered trademarks or trademarks of Microsoft Corporation in the U.S.A. and/or other countries.
- Adobe Acrobat and Adobe Reader are trademarks of Adobe Systems Incorporated.
- IBM and IBM PC/AT are trademarks of International Business Machines Corporation.

All other company and product names in this Operation Guide are trademarks or registered trademarks of their respective companies. The designations™ and ® are omitted in this guide.



# 2 Before Using the Fax Machine

This chapter explains the following topics:

Part Names and Functions .....	2-2
Machine .....	2-2
Operation Panel .....	2-4
Touch Panel .....	2-5
Previewing Images .....	2-7
Using the Enter Key .....	2-11
Using the Quick No. Search Key .....	2-11
Quick Setup Wizard .....	2-12
Fax setup items .....	2-12
Power Off setup items .....	2-13
Fax and Power Off setup procedure .....	2-14
Setting Date and Time .....	2-15
Registering Destinations in the Address Book .....	2-16
Adding a Destination (Address Book) .....	2-16
Adding a Destination on One Touch Key .....	2-25
Quick Setup Screen .....	2-28
Functions Available for Registration in the Quick Setup Screen .....	2-28
Changing Registration .....	2-29
Registering Shortcuts .....	2-30
Adding Shortcuts .....	2-30
Editing Shortcuts .....	2-31
Deleting Shortcuts .....	2-31

# Part Names and Functions

## Machine

This chapter explains the names of parts when the machine is used as a fax machine. For the parts required when functions other than FAX are used, refer to the following:

➔ *Machine's Operation Guide*

TASKalfa 6053ci/TASKalfa 5053ci/  
 TASKalfa 4053ci/TASKalfa 3553ci/  
 TASKalfa 3253ci/TASKalfa 2553ci/  
 TASKalfa 6003i/TASKalfa 5003i

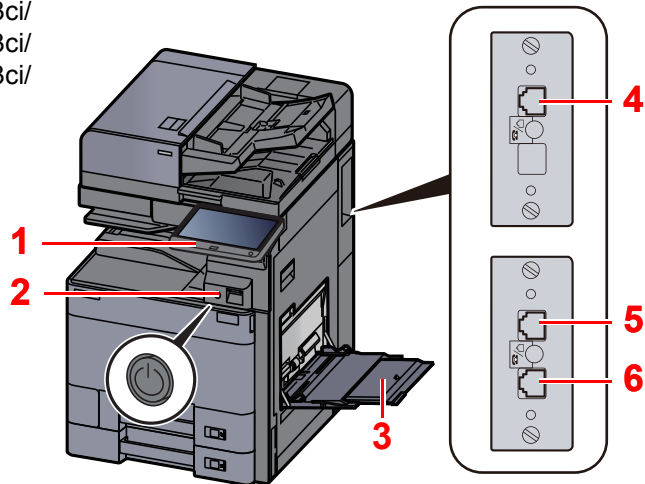

TASKalfa 8353ci/  
 TASKalfa 7353ci/  
 TASKalfa 9003i/  
 TASKalfa 8003i/  
 TASKalfa 7003i

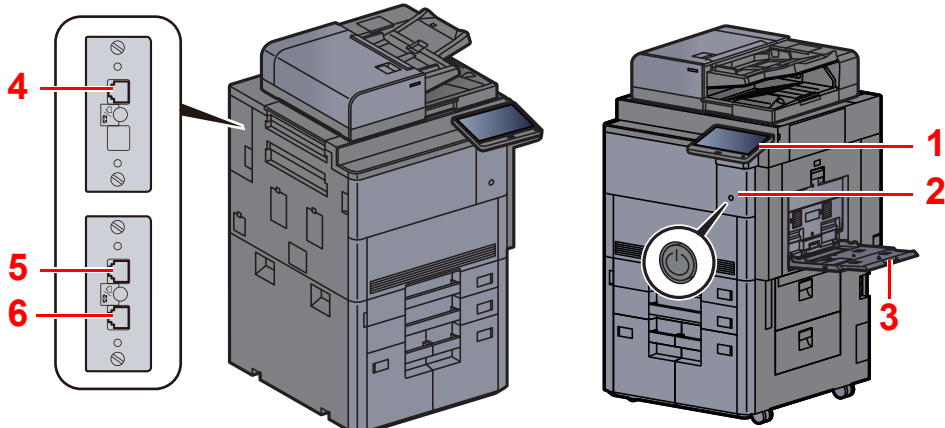

1	Operation panel	Perform the fax operation with this panel.
2	Power switch	Set this switch to the ON side when performing the fax or copier operation. The touch panel lights to enable operation.
3	MP (Multipurpose) tray	Set the paper in this tray when using a type of paper other than the cassette (e.g., when using special paper).
4	LINE connector (L2)	If you install 2 optional FAX Kits (Dual FAX option), you can use Port 2. Connect the modular cord for the telephone line to this connector.
5	LINE connector (L1)	Connect the modular cord for the telephone line to this connector. This connector is Port 1.
6	TEL connector (T1)	When using a commercially available telephone set, connect the modular cord to this connector.



**IMPORTANT**

You cannot automatically receive a fax when the power switch is turned off.

## Document Processor

(Option)

TASKalfa 6053ci/TASKalfa 5053ci/  
 TASKalfa 4053ci/TASKalfa 3553ci/  
 TASKalfa 3253ci/TASKalfa 2553ci/  
 TASKalfa 6003i/TASKalfa 5003i

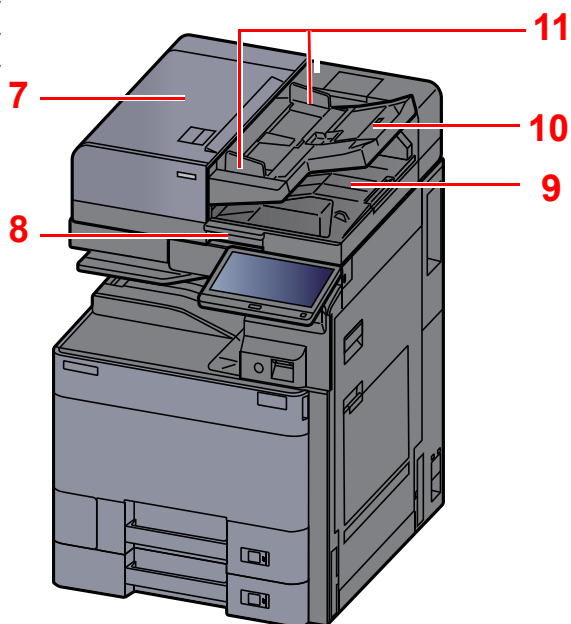

TASKalfa 8353ci/TASKalfa 7353ci/  
 TASKalfa 9003i/TASKalfa 8003i/  
 TASKalfa 7003i

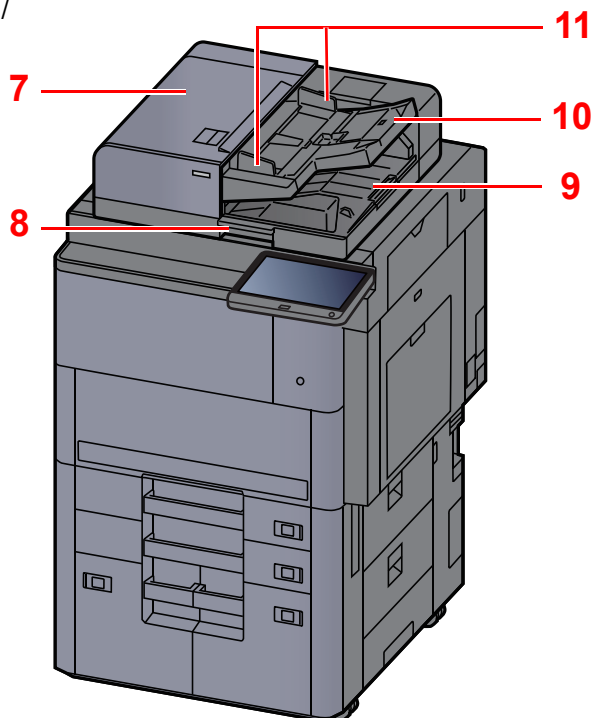

7	Top cover	Open this cover when the original jammed in the Document Processor.
8	Opening handle	Hold this handle when opening or closing the Document Processor.
9	Original eject table	Read originals are ejected onto this table.
10	Original table	Stack the sheet originals on this table.
11	Original width guides	Adjust these guides according to the original width.

## Operation Panel

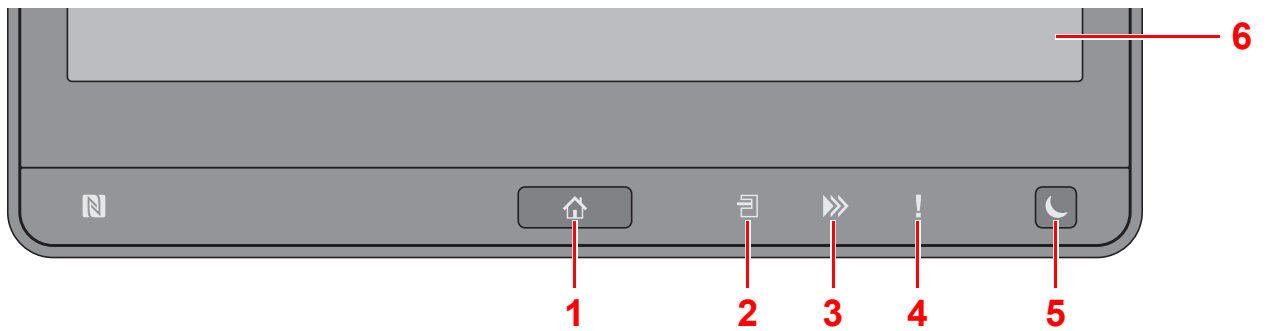

- 1 **[Home]** (🏠) key: Displays the Home screen.
- 2 **[Job Separator]** (📄) indicator: Lights when there is paper in the job separator tray.

### NOTE

There is no **[Job Separator]** lamp in TASKalfa 8353ci/TASKalfa 7353ci/TASKalfa 9003i/TASKalfa 8003i/TASKalfa 7003i.

- 3 **[Data]** (▶▶▶) indicator: Blinks while the machine is printing or sending/receiving, or accessing the hard disk/SSD. Also, it lights when there is a sending job FAX using delayed transmission.
- 4 **[Attention]** ( ! ) indicator: Lights or blinks when an error occurs and a job is stopped.
- 5 **[Energy Saver]** (☾) key: Puts the machine into Sleep Mode. Recovers from Sleep if in Sleep Mode.
- 6 Touch Panel: Displays icons for configuring machine settings.

## Touch Panel

### Using the Touch Panel

Keys for basic operation are displayed on the lower side and the right side of the touch panel.

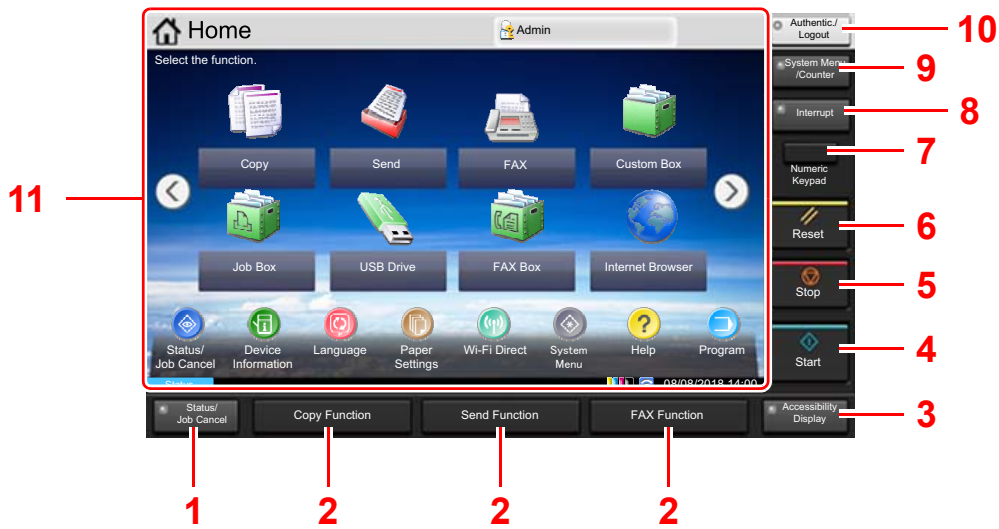

- 1 **[Status/Job Cancel]** key: Displays the Status/Job Cancel screen.
- 2 **Function Key:** These keys enable various functions and applications, including copy and scan, to be registered.  
➔ [Function Key Assignment \(page 8-8\)](#)
- 3 **[Accessibility Display]** key: Switches the touch panel display on the Copy screen and the Send screen to a magnified view.
- 4 **[Start]** key: Starts copying and scanning operations and processing for setting operations.
- 5 **[Stop]** key: Cancels or pauses the job in progress.
- 6 **[Reset]** key: Returns settings to their default states.
- 7 **[Numeric Keypad]** key: Displays numeric keys on the touch panel.
- 8 **[Interrupt]** key: Displays the Interrupt Copy screen.
- 9 **[System Menu/Counter]** key: Displays the System Menu screen.
- 10 **[Authentication/Logout]** key: Authenticates user switching, and exits the operation for the current user (i.e. log out).
- 11 **Screen area:** Displays the screen of each function.

## Home Screen

This screen is displayed by selecting the [Home] (🏠) key on the operation panel. Selecting an icon will display the corresponding screen.

You can change the icons to display on the Home screen as well as its background.

➔ Machine's *Operation Guide*

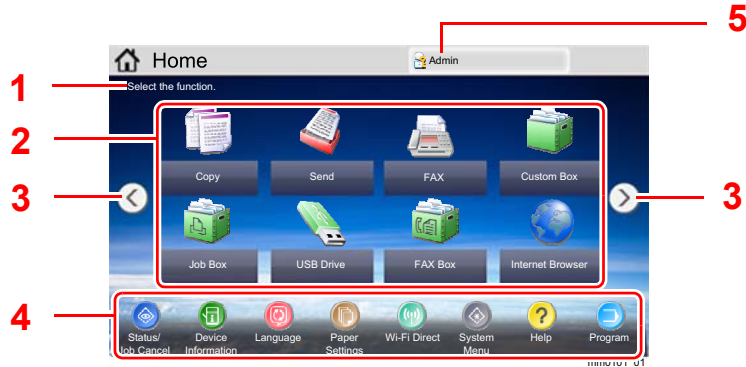

\* The appearance may differ from your actual screen, depending on your configuration and option settings.

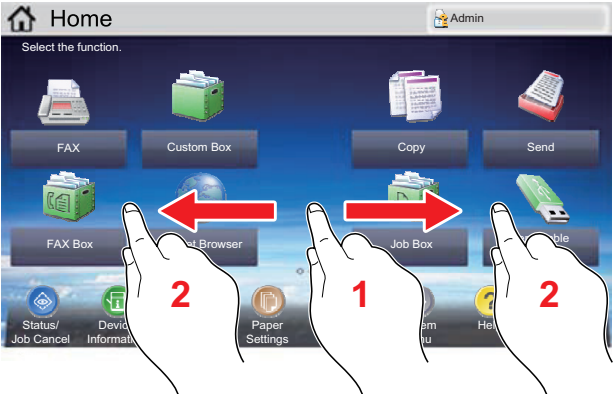
No.	Item	Description
1	Message	Displays the message depending on the status.
2	Desktop	Displays function icons including the functions registered in program. Icons that are not displayed on the first page will appear by changing the page.
3	Screen-switching keys	<p>Use these buttons to switch between desktop pages.</p> <p> <b>NOTE</b></p> <p>You can also switch views by touching the screen and moving the finger sideways (i.e. swiping).</p> 
4	Taskbar	Displays task icons.
5	Login User Name	Displays the logged-in user name. This is displayed when user login administration is enabled. Selecting "Login User Name" will display the information of the logged-in user.

## Operating the touch panel

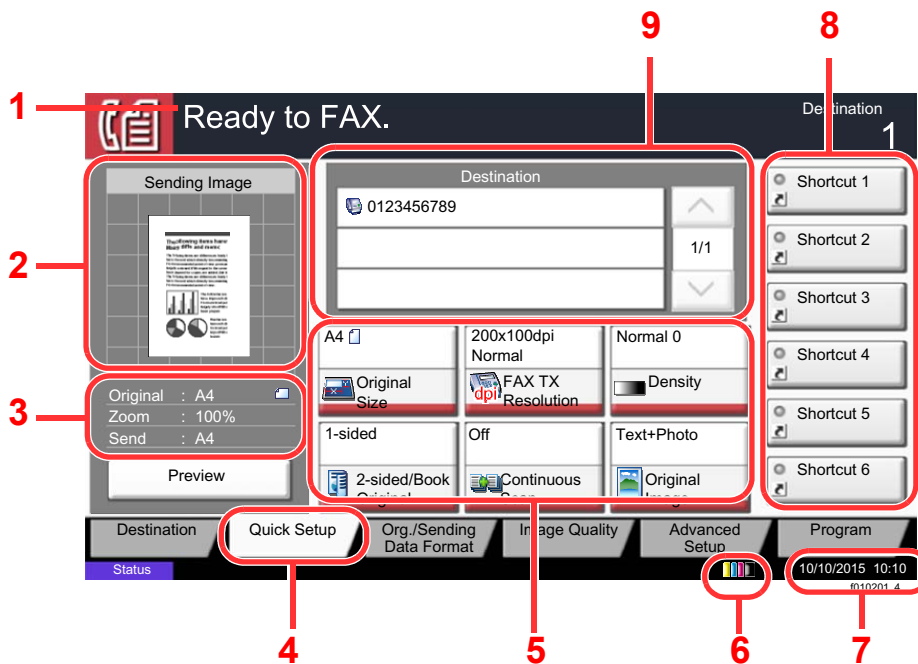

- 1 Displays the status of the equipment as well as necessary operation messages.
- 2 Shows an image of the document to be sent.
- 3 Original : Shows the original size when the original is placed.  
Zoom : Shows the magnification of the document to be sent.  
Send : Shows the size of the document to be sent.
- 4 Displays the Quick Setup screen.
- 5 Set the fax functions.
- 6 Remaining amount of toner.
- 7 Displays the time.
- 8 Displays registered shortcuts.
- 9 Displays the destinations.

## Previewing Images

You can display a preview image of a scanned original on the panel to check the image to be sent.

### 1 Display the screen.

Prepare to send the image as described in Basic transmission procedure.

➔ [Basic transmission procedure \(page 3-2\)](#)

### 2 Display a preview image.

- 1 Select [Preview].

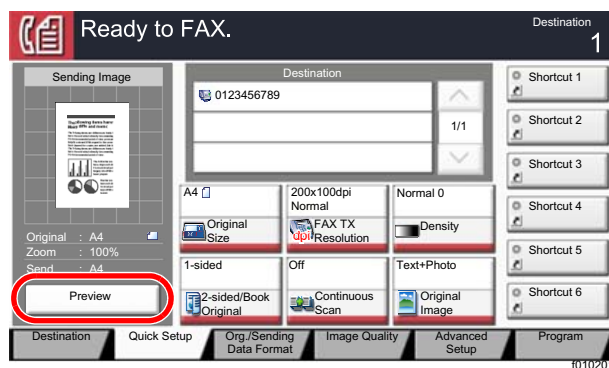

## 2 Select [Detail].

You can check the sending image in greater detail.

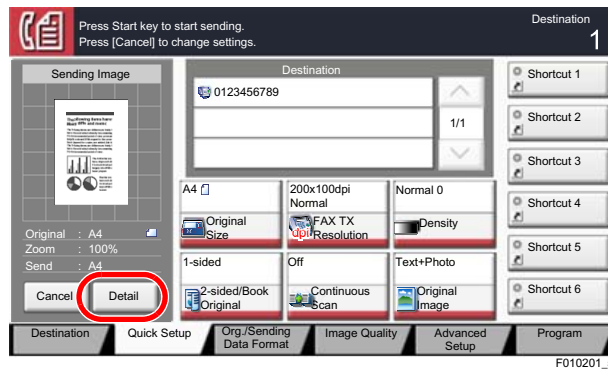

In magnified view, you can move the range of display.

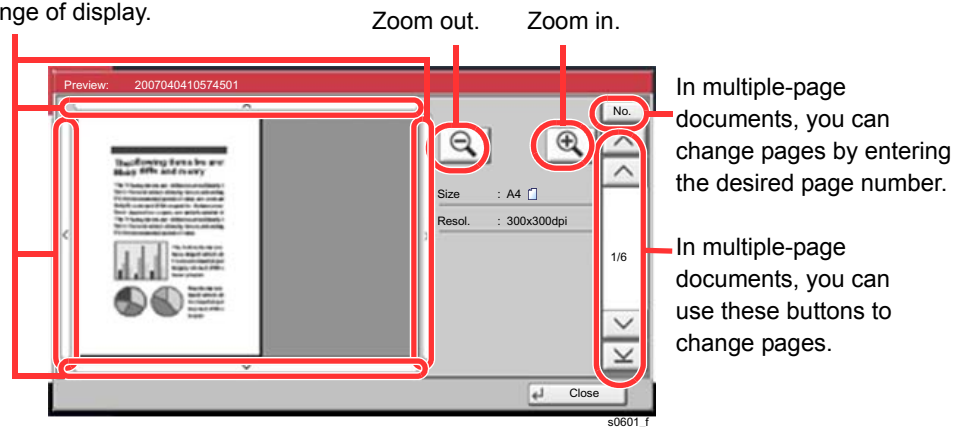

### NOTE

The following items are displayed on the preview screen.

- Size
- Resolution

#### ➔ [Fax transmission functions \(page 3-19\)](#)

If you have placed a multiple-page original in the document processor, the machine scans all the originals but only the first page is previewed. **[Detail]** can be selected to view all preview images. Select [ $\downarrow$ ] to move through the preview images in the order they were scanned.

You cannot change the transmission functions while the preview image is displayed.

To change any of the transmission functions, select the **[Stop]** key or select **[Cancel]**. The preview image disappears and the destination is cancelled. To see the preview again, make the transmission function changes and select the destination.



- 3 Press the [**Start**] key to send the fax.

Transmission begins.



**NOTE**

When [**On**] is selected in [**Destination Check before Send**], a destination confirmation screen is displayed when you press the [**Start**] key.

➔ *Machine's Operation Guide*

To see a preview image when you are using the document processor, place the originals in the document processor again.

A document stored in a polling box for polling transmission can be previewed in the same way.

➔ [Polling Communication \(page 5-28\)](#)

You cannot preview images in the following situations:

- When you are using Mixed Sized Originals mode
- During a direct transmission
- During polling reception
- When [**On**] is selected in the Long Original setting

### Using the Preview Screen

When the Preview screen is displayed, you can do the following by moving the finger that is touching the touch panel.

Function	Description
<b>Drag</b>	With the finger touching the touch panel, slide the finger to move the position of the displayed preview.
<b>Pinch in Pinch out</b>	With two fingers touching the touch panel, widen or tighten the space between the two fingers to zoom in and out on the view.

## Entering Numbers



### NOTE

Numeric keys do not appear on the touch panel if an optional numeric keypad is installed.

### When Numeric Keys are Provided on the FAX Base Screen

There are numeric keys on the fax base screen. Use these numeric keys to enter the destination number.

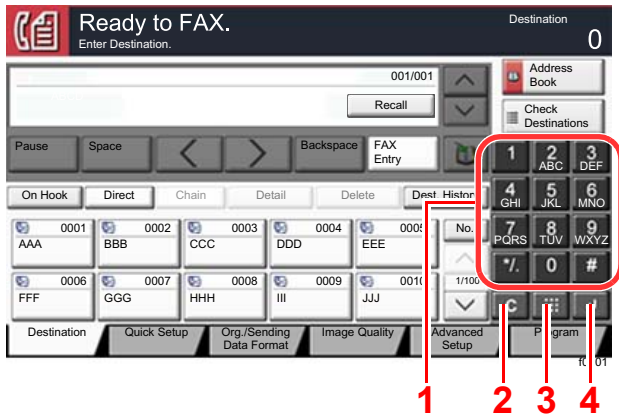

- 1 Enter numbers and symbols.
- 2 Clear entered numbers.
- 3 Quick No. Search key.
  - [Using the Quick No. Search Key \(page 2-11\)](#)
- 4 Entry by numeric keys is confirmed.
  - [Using the Enter Key \(page 2-11\)](#)

### When Numeric Keys are not Provided on the FAX Base Screen

When entering numbers, numeric keys appear on the touch panel if you select the [Numeric Keypad] key or select the area in which the number is entered.

#### Example: When searching for an address number

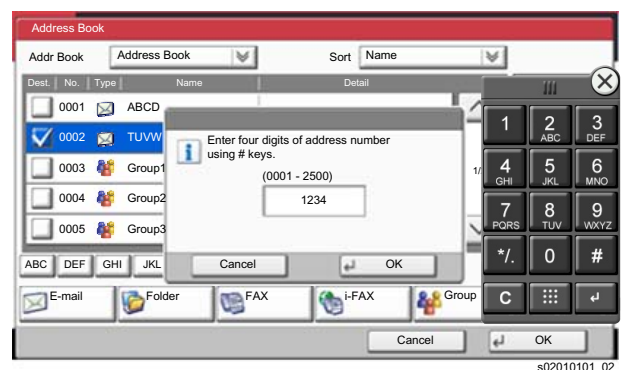
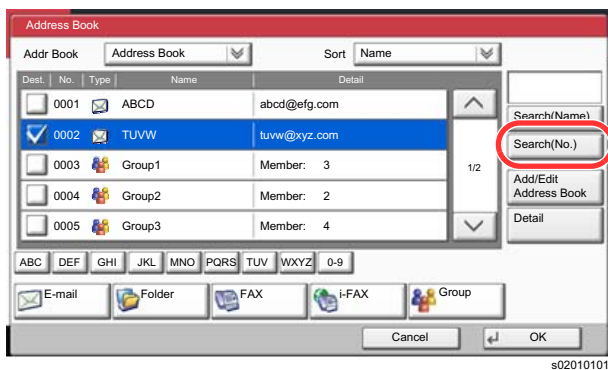

**NOTE**

- Moving your finger while touching the top of the numeric keypad enables you to freely move to any key. (Drag operation)

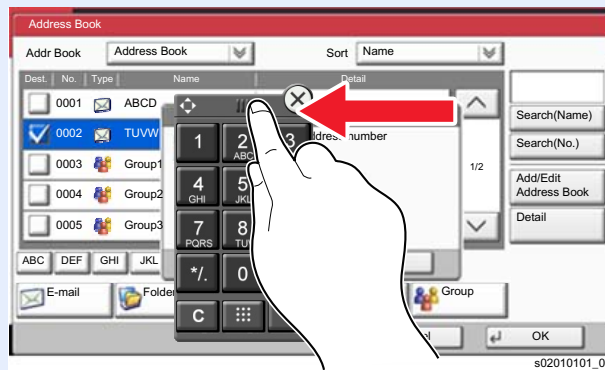

## Using the Enter Key

The Enter key has the same function as the key with the Enter mark (↵), such as the [OK ↵] key and the [Close ↵].

## Using the Quick No. Search Key

The Quick No. Search key performs the same action as the [No.] displayed on the touch panel. Use the Quick No. Search keys to perform an action by simply entering a number directly using the numeric keys. For example, you can specify the speed dial for a transmission destination or recall a stored program by its program number.

For more information on speed dialing, refer to the following:

- ➔ [Choosing from the Speed Dial \(page 3-11\)](#)

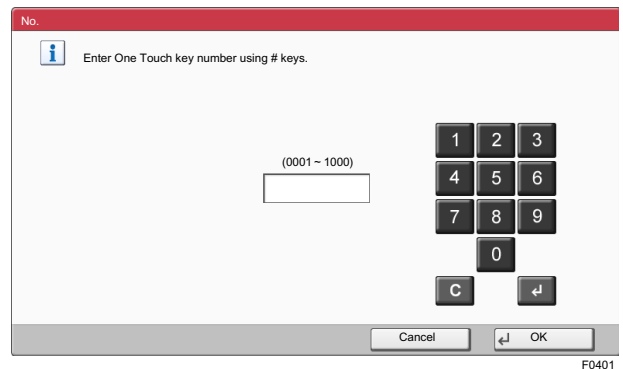
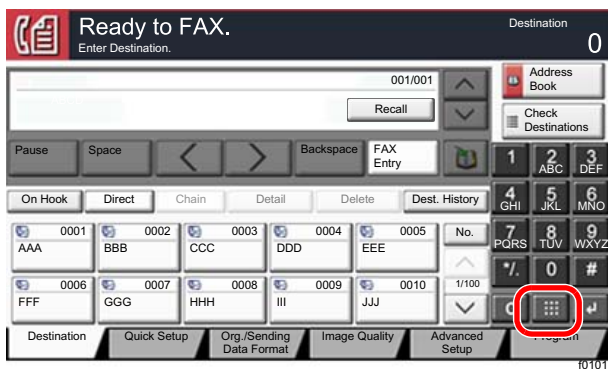

## Quick Setup Wizard

In quick setup mode, a wizard is used to configure the following settings. Be sure to complete the settings before using the fax system.

### Fax setup items

Step	Setting item	Description	Reference Page
1. Dialing/RX Mode	Dialing Mode(Port 1) <sup>*1</sup> Dialing Mode(Port 2) <sup>*1*2</sup>	Select the dialing mode according to the line type.	<a href="#">8-11</a> <a href="#">8-11</a>
	Reception Mode	Select the reception mode.	<a href="#">8-13</a>
	Auto (DRD) <sup>*3</sup>	Select the reception pattern.	<a href="#">8-13</a>
2. Local Fax Information	Local FAX Name(Port 1) Local FAX Name(Port 2) <sup>*2</sup>	Register the local fax name printed on the fax on the receiving system.	<a href="#">8-10</a> <a href="#">8-10</a>
	Local FAX Number(Port 1) Local FAX Number(Port 2) <sup>*2</sup>	Enter the local fax number to be printed on the fax on the receiving system.	<a href="#">8-11</a> <a href="#">8-11</a>
	Local FAX ID	Enter the local fax ID. The local fax ID can limit other parties with which you can communicate. Enter the four-digit local FAX ID number.	<a href="#">8-11</a>
	TTI	Select whether or not to print the local fax information on the fax on the receiving system.	<a href="#">8-10</a>
3. Sound	FAX Speaker Volume	Set the volume when selecting [ <b>On Hook</b> ]. Speaker Volume: Volume of the built-in speaker when the line is connected by selecting [ <b>On Hook</b> ].	<a href="#">8-6</a>
	FAX Monitor Volume	Set the monitor volume. Monitor Volume: Volume of the built-in speaker when the line is connected without selecting [ <b>On Hook</b> ] such as in memory transmission.	<a href="#">8-6</a>
	Job Finish Buzzer	Emit a sound when a print job is normally completed.	<a href="#">8-6</a>
4. Rings	Rings(Normal) <sup>*4</sup>	Set number of times to let phone ring before answering a call.	<a href="#">8-13</a>
	Rings(FAX/TEL) <sup>*4</sup>	Set number of times to let phone ring before taking over from the answering machine.	<a href="#">8-13</a>
	Rings(TAD) <sup>*4</sup>	Set number of times to let phone ring before switching the FAX and the phone.	<a href="#">8-13</a>

Step	Setting item	Description	Reference Page
5. Paper Source/ Output	Paper Source Settings	Specify the paper type or cassette to be used for print output of the received fax. If selecting [Specify by Media Type], refer to the following. ➔ <a href="#">Media Type (page 8-12)</a> If selecting [Specify by Cassette], refer to the following. ➔ <a href="#">FAX Exclusive Paper Source (page 8-12)</a>	<a href="#">8-12</a> <a href="#">8-12</a>
	Paper Output (Port 1) Paper Output (Port 2) <sup>*2</sup>	Select paper output for the received FAX. <sup>*5</sup>	<a href="#">8-7</a>
	Reduced RX Size	Reduces the received FAX size before printing if the size is larger than the current paper size.	<a href="#">8-12</a>
6. Redial	Retry Times	Set the number of redials.	<a href="#">8-10</a>

\*1 Inch version only.

\*2 This is displayed when the option of two fax kits has been installed.

\*3 DRD reception mode is available for some countries.

\*4 This setting does not appear in some regions.

\*5 This function may not be displayed, depending on the installed options.



**NOTE**

The settings can be changed in the system menu.

➔ [Default fax settings \(page 8-2\)](#)

## Power Off setup items

Step	Setting item	Description	Reference Page
Power Off Setup	Show Power Off Message	Set the mode whether display a confirmation message in power supply off.	<a href="#">8-8</a>



**NOTE**

The settings can be changed in the system menu.

➔ [Show Power Off Message \(page 8-8\)](#)

## Fax and Power Off setup procedure

### NOTE

If the user authentication screen appears, enter your login user name and login password and select [**Login**].

The factory default login user name and login password are set as shown below.

Model Name	Login User Name	Login Password
TASKalfa 2553ci	2500	2500
TASKalfa 3253ci	3200	3200
TASKalfa 3553ci	3500	3500
TASKalfa 4053ci	4000	4000
TASKalfa 5003i/TASKalfa 5053ci	5000	5000
TASKalfa 6003i/TASKalfa 6053ci	6000	6000
TASKalfa 7003i	7000	7000
TASKalfa 7353ci	7300	7300
TASKalfa 8003i	8000	8000
TASKalfa 8353ci	8300	8300
TASKalfa 9003i	9000	9000

### 1 Display the screen.

[System Menu/Counter] key > [Quick Setup Wizard] > "FAX Setup" [Next]

### 2 Configure the function.

Start the wizard. Follow the instructions on the screen to configure settings.

Control	Description
End	Exits the wizard.
Previous	Returns to the previous item.
Skip	Advances to the next item without setting the current item.
Next	Advances to the next screen.
Back	Returns to the previous screen.

When you have completed the settings, select [**finish**].

# Setting Date and Time

Set the local date and time at the place of installation.

When you send a fax using the transmission function, the date and time as set here will be printed in the header of the fax. Set the date, time and time difference from GMT of the region where the machine is used.

## NOTE

Be sure to set the time difference before setting the date and time.

If user login administration is enabled, you can only change the settings by logging in with administrator privileges or as a user with privileges to configure this setting.

The factory default login user name and login password are set as shown below.

Model Name	Login User Name	Login Password
TASKalfa 2553ci	2500	2500
TASKalfa 3253ci	3200	3200
TASKalfa 3553ci	3500	3500
TASKalfa 4053ci	4000	4000
TASKalfa 5003i/TASKalfa 5053ci	5000	5000
TASKalfa 6003i/TASKalfa 6053ci	6000	6000
TASKalfa 7003i	7000	7000
TASKalfa 7353ci	7300	7300
TASKalfa 8003i	8000	8000
TASKalfa 8353ci	8300	8300
TASKalfa 9003i	9000	9000

## 1 Display the screen.

[System Menu/Counter] key > [Date/Timer/Energy Saver]

## 2 Configure the settings.

Select and set in the order [Time Zone] > [Date/Time] > [Date Format]

Item	Description
<b>Time Zone</b>	Set the time difference from GMT. Choose the nearest listed location from the list. If you select a region that utilizes summer time, configure settings for summer time.
<b>Date/Time</b>	Set the date and time for the location where you use the machine. When the machine sends a fax, the date and time set in the machine are recorded in the fax header. <b>Value:</b> Year (2000 to 2035), Month (1 to 12), Day (1 to 31), Hour (00 to 23), Minute (00 to 59), Second (00 to 59)
<b>Date Format</b>	Select the display format of year, month, and date. The year is displayed in Western notation. <b>Value:</b> Month/Day/Year, Day/Month/Year, Year/Month/Day

# Registering Destinations in the Address Book

Save frequently used destinations to the Address Book or One Touch Key. The saved destinations can be changed. The destinations are available for Send as E-mail, Send to Folder, and Fax Transmission.

## NOTE

Registering and editing of the Address Book can also be done in Command Center RX.

➔ *Machine's Operation Guide*

Editing of the Address Book and One Touch Keys can be restricted to administrators.

➔ *Machine's Operation Guide*

## Adding a Destination (Address Book)

Add a new destination to the Address Book. There are two registering methods, contacts and groups. When adding a group, enter the group name and select group members from the Address Book.

## NOTE

If registering and editing of the Address Book is restricted to administrators, you can edit the Address Book by logging in with administrator privileges.

➔ *Machine's Operation Guide*

➔ *Command Center RX User Guide*

## Registering a contact address

A maximum of 2,000 contact addresses can be registered. Destination name, fax number, sub address communication, encryption, transmission start speed, and ECM can be registered for each destination.

### 1 Display the screen.

[System Menu/Counter] key > [Edit Destination] > "Address Book" [Add/Edit] > [Add] > [Contact] > [Next]

### 2 Add the name.

1 Select "Address Number" [Change].

2 Use [+] / [-] or the numeric keys to enter an address number (1 to 2500).

To have the number assigned automatically, enter "0000".

## NOTE

Address Number is an ID for a destination. You can select any available number out of 2,000 numbers for contacts and 500 numbers for groups.

If you specify an address number that is already in use, an error message appears when you select [Save] and the number cannot be registered. If you set "0000" as the address number, the address is registered under the lowest available number.

3 Select [OK].

The screen shown in step 1 reappears.

4 Select "Name" [Change].



- 5 Enter the destination name to be displayed on the Address Book and select **[OK]**.

The screen shown in step 1 reappears.

 **NOTE**

Up to 32 characters can be entered.

Refer to the following for details on entering characters.

➔ [Character Entry Method \(page 12-2\)](#)

### 3 Enter the fax number.

- 1 Select **[FAX]**.
- 2 Enter the fax number of the receiving system.

 **NOTE**

Up to 32 digits can be entered.

Use the numeric keys to enter a number.

Key	Description
Pause	Selecting this key adds about three seconds of waiting time during dialing. For example, when dialing the receiving system on an external line, you can use this method to insert a pause before resuming dialing after you dial a specific number.
Space	It is possible to enter half-width spaces in the entry of the destination number. This is useful when checking if the destination number has been entered correctly.
< >	Moves the cursor.
Backspace	To correct the fax number, select <b>[Backspace]</b> on the touch panel, and delete the digits one by one before reentering the fax number. To delete the number entirely, select the <b>[Clear]</b> key on the numeric keys.

### 4 Set a sub address.

To use sub address communication, a sub address and password must be registered.

- 1 Select "Sub Address" **[Change]**.
- 2 Enter the sub address and password, and select **[OK]**.  
For the procedure for setting a sub address, refer to the following:

➔ [Sub Address Transmission \(page 5-25\)](#)

## 5 Configure the transmission settings.

The transmission start speed, ECM, and encrypted key No. can be set.

"TX Start Speed", "ECM and Encryption Key No." [**Change**], set each item then select [**OK**].

Key	Description
Encryption Key No.	This is set when using encrypted transmission to send the data. ➔ <a href="#">Using the Encrypted Transmission (page 5-39)</a>
TX Start Speed	This is set to change the transmission start speed. Select the speed from 33,600 bps, 14,400 bps, and 9,600 bps.  <b>NOTE</b> Normally the default setting should be used.
ECM	ECM is a communication mode specified by the ITU-T (International Telecommunication Union) that retransmits data when an error occurs. Fax machines that have ECM mode check for errors as they communicate, preventing distortion of the image due to noise on the line and other conditions.

## 6 Check if the destination entry is correct > [**Save**]

The destination is added to the Address Book.

To register the registered address in a one-touch key, select [**Save**] > [**Yes**]



### NOTE

Refer to the following for registering the One Touch Key.

➔ [Adding a Destination on One Touch Key \(page 2-25\)](#)

## Registering a contact address (i-FAX)

Up to 2,000 contacts can be registered. Contact name, i-FAX address, transmission mode and the conditions for the destination machine can be registered for each contact.

### NOTE

For details, refer to the following:

➔ [Internet Faxing \(i-FAX\) \(page 10-1\)](#)

### 1 Display the screen.

[System Menu/Counter] key > [Edit Destination] > "Address Book" [Add/Edit] > [Add] > [Contact] > [Next]

### 2 Add the name.

1 Select "Address Number" [Change].

2 Use [+] / [-] or the numeric keys to enter an address number (1 to 2500).

To have the number assigned automatically, enter "0000".

### NOTE

Address Number is an ID for a destination. You can select any available number out of 2,000 numbers for contacts and 500 numbers for groups.

If you specify an address number that is already in use, an error message appears when you select [Save] and the number cannot be registered. If you set "0000" as the address number, the address is registered under the lowest available number.

3 Select [OK].

The screen shown in step 1 reappears.

4 Select "Name" [Change].

5 Enter the destination name to be displayed on the Address Book and select [OK].

The screen shown in step 1 reappears.

### NOTE

Up to 32 characters can be entered.

Refer to the following for details on entering characters.

➔ [Character Entry Method \(page 12-2\)](#)

### 3 Enter the destination i-FAX address (Email address).

1 Select [i-FAX].

2 Select "i-FAX Address" [Change].

- 3 Enter the destination i-FAX address (E-mail address) and select **[OK]**.  
To send by Direct SMTP, enter the IP address of the other machine.

 **NOTE**

Up to 256 characters can be entered.

For details on character entry, refer to the following:

➔ [Character Entry Method \(page 12-2\)](#)

## 4 Configure the transmission settings.

- 1 Select "Mode" [☑] and select **[Simple]** or **[Full]**.

Transmission mode	Description
Simple mode	Transmission confirmation is not sent to the destination machine.
Full mode	Transmission confirmation is sent to the destination machine.

- 2 Select "Via Server" [☑] and select **[On]** or **[Off]**.  
When this setting is set to **[Off]**, transmission takes place by direct SMTP (not through an e-mail server).  
When this setting is set to **[On]**, transmission takes place by the i-FAX method (through an e-mail server).

- 3 Select "Paper Size" **[Change]**.

- 4 Specify the destination conditions and select **[OK]**.

Item	Description
Resolution	Specify the resolutions that can be received by the destination fax machine. If you try to send an i-FAX using a prohibited resolution, it is automatically changed to a permitted resolution and then sent. <ul style="list-style-type: none"> <li>• 200 × 100 dpi: Permitted (fixed)</li> <li>• 200 × 200 dpi: Permitted (fixed)</li> <li>• 200 × 400 dpi: Permitted or prohibited</li> <li>• 400 × 400 dpi: Permitted or prohibited</li> <li>• 600 × 600 dpi: Permitted or prohibited</li> </ul> To permit a resolution setting, select the key for that resolution so that it is highlighted. To prohibit a resolution, select the key again so that it is no longer highlighted.
Compression	Select a suitable file format for the destination fax machine. MH, MR, MMR or JBIG
Paper Size	Display the sending paper size for the destination fax machine. <ul style="list-style-type: none"> <li>• A4/Letter: Permitted (fixed)</li> <li>• B4: Permitted or prohibited</li> <li>• A3/Ledger: Permitted or prohibited</li> </ul>

## 5 Check if the destination entry is correct > [Save]

The destination is added to the Address Book.

To register the registered address in a one-touch key, select **[Save]** > **[Yes]**



### NOTE

Refer to the following for registering the One Touch Key.

➔ [Adding a Destination on One Touch Key \(page 2-25\)](#)

## Adding a Group

Compile two or more contacts into a group. Designations in the group can be added at the same time. When adding a group, a maximum of 500 groups can be added in the Address Book.



### NOTE

To add a group, you need individually added destinations. Register one or more individual destinations as needed before proceeding. Up to 100 destinations for the E-mail, 500 destinations for the FAX, 100 destinations for the i-FAX, and a total of 10 destinations for the FTP and SMB can be registered per group.

## 1 Display the screen.

[System Menu/Counter] key> [Edit Destination] > "Address Book" [Add/Edit] > [Add] > [Group] > [Next]

## 2 Add the name.

1 Select "Address Number" [Change].

2 Use [+]/[-] or the numeric keys to enter an address number (1 to 2,500).

To have the number assigned automatically, set "0000".



### NOTE

Address Number is an ID for a group. You can select any available number out of 2,000 numbers for contacts and 500 numbers for groups.

If you specify an address number that is already in use, an error message appears when you select **[Save]** and the number cannot be registered. If you set "0000" as the address number, the address is registered under the lowest available number.

3 Select **[OK]**. The "Add Group" screen reappears.

4 Select "Name" [Change].

5 Enter the group name displayed on the Address Book > **[OK]**

The "Add Group" screen reappears.



### NOTE

Up to 32 characters can be entered.

Refer to the following for details on entering characters.

➔ [Character Entry Method \(page 12-2\)](#)

### **3 Select the members (destinations).**

- 1** [Member] > [Add]
- 2** Select destinations (contacts) to add to the group > [OK]



#### **NOTE**

Destinations can be sorted or searched by destination name or address number.

➔ [Choosing from the Address Book \(page 3-9\)](#)

If you have more destinations to add, repeat Steps 2.

### **4 Check if the selected destination was added to the group > [Save]**

The group is added to the Address Book.

To register the registered address in a one-touch key, select [Save] > [Yes]



#### **NOTE**

Refer to the following for registering the One Touch Key.

➔ [Adding a Destination on One Touch Key \(page 2-25\)](#)

## Editing Address Book Entries

Edit the destinations (contacts) you added to the Address Book.

### 1 Display the screen.

- 1 [System Menu/Counter] key > [Edit Destination] > "Address Book" [Add/Edit]
- 2 Select a destination or group to edit > [Detail]



#### NOTE

Destinations can be sorted or searched by destination name or address number.

➔ [Choosing from the Address Book \(page 3-9\)](#)

### 2 Edit the destination.

#### Editing a Contact

- 1 Change "Name", "Address Number" and destination type and address.  
➔ [Adding a Destination \(Address Book\) \(page 2-16\)](#)
- 2 [Save] > [Yes]  
Register the changed destination.

#### Add a destination to a group

- 1 Change "Name" and "Address Number".  
➔ [Adding a Group \(page 2-21\)](#)
- 2 [Member] > [Add]
- 3 After you have completed the changes, [Save] > [Yes]  
Register the changed destination.

#### To delete any destination from the group

- 1 [Member] > Select the delete destination > [Delete] > [Yes]
- 2 After you have completed the changes, [Save] > [Yes]  
Register the changed destination.

## Deleting Address Book Entries

Delete the destinations (contacts) you added to the Address Book.

### 1 Display the screen.

- 1 [System Menu/Counter] key> [Edit Destination] > "Address Book" [Add/Edit]
- 2 Select a destination or group to delete > [Detail]



#### NOTE

Destinations can be sorted or searched by destination name or address number.

➔ [Choosing from the Address Book \(page 3-9\)](#)

### 2 [Delete] > [Yes]

Delete the contact or group.

## Printing Address List

You can print the list of destinations registered in the Address Book.

You can sort the list in the order of index or address numbers of the destinations.

### 1 Display the screen.

[System Menu/Counter] key > [Edit Destination] > [Print List]

### 2 Print.

[FAX List (Index)] or [FAX List (No.)] > [Yes]

The list is printed.

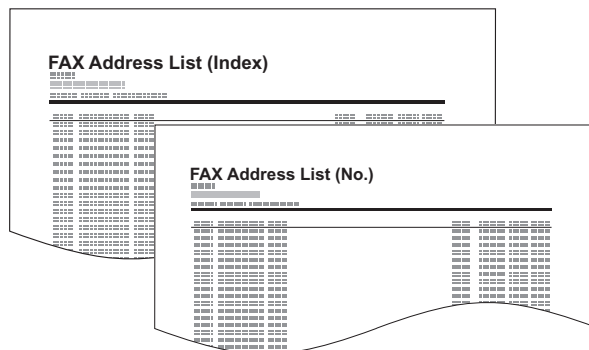



## Adding a Destination on One Touch Key

Assign a new destination (contact or group) to an one touch key. A maximum of 1,000 destinations can be registered.

### NOTE

- Refer to the following for use of One Touch Key.
  - ➔ [Choosing from the One Touch Key \(page 3-11\)](#)
- You can add One Touch keys and change their settings on Command Center RX.
  - ➔ *Machine's Operation Guide*
- If registering and editing of the One Touch Keys is restricted to administrators, you can edit the One Touch Keys by logging in with administrator privileges.
  - ➔ *Machine's Operation Guide*
  - ➔ *Command Center RX User Guide*

### 1 Display the screen.

[System Menu/Counter] key > [Edit Destination] > "One Touch Key" [Add/Edit]

### 2 Add One Touch Keys.

- 1 Select a One Touch Key number (001 to 1000) for the destination > [Add/Edit]  
Selecting [No.] or the Quick No. Search key on the numeric keypad enables direct entry of a One Touch Key number.

### NOTE

For details of Quick No. Search key, refer to the following:

- ➔ [Using the Quick No. Search Key \(page 2-11\)](#)

Select a One Touch Key with no registered destination.

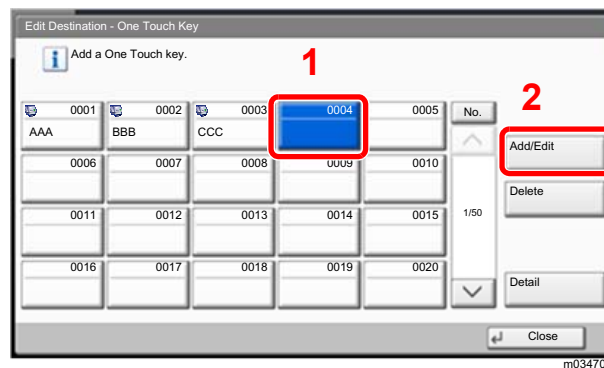

- 2 Select "Display Name" [Change].

- 3 Enter the One Touch Key name displayed in the send base screen > [Next]

### NOTE

Up to 24 characters can be entered.  
Refer to the following for details on entering characters.

- ➔ [Character Entry Method \(page 12-2\)](#)

- 4 Select "Destination" [Change].

The Address Book appears.

- 5 Select a destination (contact or group) to add to the One Touch Key number > **[OK]**  
Selecting **[Detail]** shows the detailed information of the selected destination.



**NOTE**

Destinations can be sorted or searched by destination name or address number.

➔ [Choosing from the Address Book \(page 3-9\)](#)

- 6 Select **[Save]**.  
The destination will be added to the One Touch Key.

## Editing One Touch Key

### 1 Display the screen.

- 1 **[System Menu/Counter]** key > **[Edit Destination]** > "One Touch Key" **[Add/Edit]**
- 2 Select a One Touch Key number (0001 to 1000) to edit. Selecting **[No.]** or the Quick No. Search key on the numeric keypad enables direct entry of a One Touch Key number.

### 2 Changing the Registered Information.

- 1 Select **[Add/Edit]**.
- 2 Select a new destination (contact or group). Selecting **[Detail]** shows the detailed information of the selected destination.



**NOTE**

Destinations can be sorted or searched by destination name or address number.

➔ [Choosing from the Address Book \(page 3-9\)](#)

- 3 **[OK]** > **[OK]** > **[Save]** > **[Yes]**  
Add the destination to the One Touch Key.

## Deleting the Destination to the One Touch Key

### 1 Display the screen.

- 1 **[System Menu/Counter]** key > **[Edit Destination]** > "One Touch Key" **[Add/Edit]**
- 2 Select a One Touch Key number (0001 to 1000) to edit. Selecting **[No.]** or the Quick No. Search key on the numeric keypad enables direct entry of a One Touch Key number.

### 2 Delete the Registered Information.

Select **[Delete]** > **[Yes]**

The data registered in the One Touch Key is deleted.

## Printing One Touch Key List

You can print the list of destinations registered in the One Touch Key List.

You can select the list for all addresses or only fax addresses of the destinations.

**1 Display the screen.**

[System Menu/Counter] key > [Edit Destination] > [Print List]

**2 Print.**

[One Touch Key List (All)] or [One Touch Key List (FAX)] > [Yes]

The list is printed.

## Quick Setup Screen

To display the Quick Setup Screen, which shows frequently used fax send settings, select **[Quick Setup]** tab in the fax base screen.

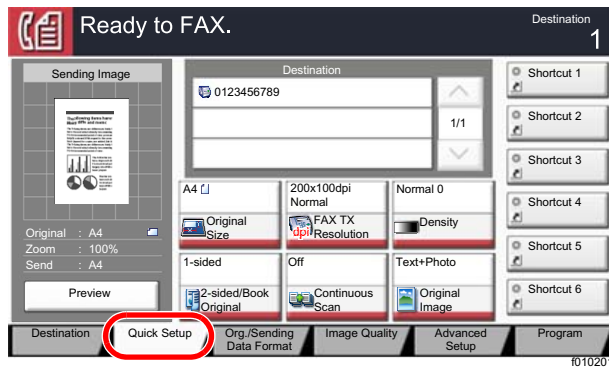

### NOTE

The settings that can be configured in the Quick Setup Screen are basic settings. To configure advanced settings, use the **[Org./Sending Data Format]**, **[Image Quality]**, and **[Advanced Setup]** screens.

## Functions Available for Registration in the Quick Setup Screen

Default registrations and the functions available for registration are as follows.

Default Registration	Functions Available for Registration
1: Original Size 2: FAX TX Resolution 3: Density 4: 2-sided/Book Original* <sup>1</sup> 5: Continuous Scan 6: Original Image	Original Size 2-sided/Book Original* <sup>1</sup> Sending Size Original Orientation Density Original Image FAX TX Resolution Zoom Continuous Scan

\*1 If the document processor is option and not installed, use "Book Original".

## Changing Registration

The following procedure is one example for replacing the registration of [Density] with [Zoom] in the Quick Setup Screen for faxing.

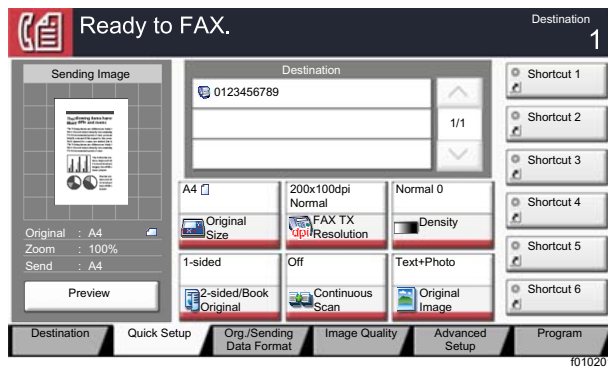

### 1 Display the screen.

[System Menu/Counter] key > [FAX] > "Quick Setup Registration" [Next] > "Zoom" [Change]

### 2 Changing Registration.

1 Select [Key 3] here as the key to set replacement location.

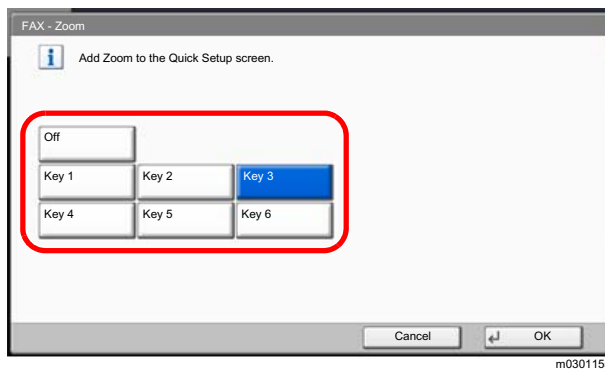

2 [OK] > [Yes]  
[Zoom] will be Key 3 newly registered.

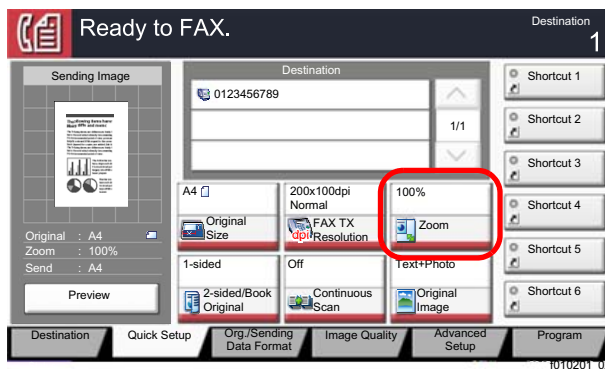

# Registering Shortcuts

You can register shortcuts in the Quick Setup screen for easy access to the frequently used functions. The settings for the selected function can also be registered. A function name linked to a registered shortcut can be changed as necessary.

## Adding Shortcuts

Shortcut registration is performed in the setup screen of each function. Shortcuts can be registered for all functions in which **[Add Shortcut]** appears on the screen.

- 1** In each function, display the configuration screen you want to register.
- 2** Register the shortcuts.
  - 1** Select the setting you want to add.
  - 2** Select **[Add Shortcut]**.

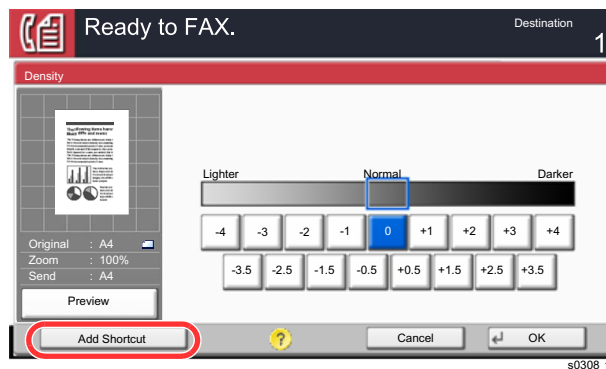

- 3** Select the keys corresponding to the shortcut number (1 to 6) to register.



### NOTE

If you select a shortcut number already registered, the currently registered shortcut can be replaced with a new one.

- 4** Enter the shortcut name > **[Save]**.

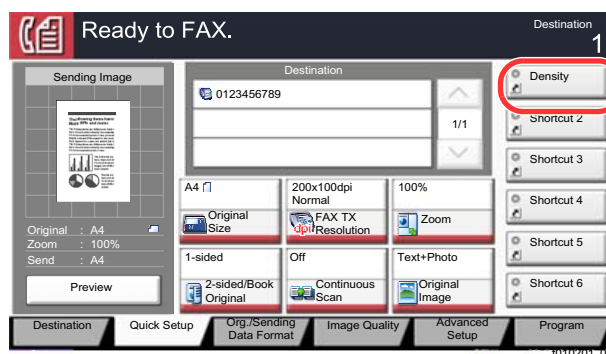

The shortcut is registered.

## Editing Shortcuts

- 1** In the setup screen of each function, select **[Add Shortcut]** in the bottom of the screen.
- 2** Edit the shortcut
  - 1** Select **[Edit]**.
  - 2** Select the shortcut key you want to edit.
  - 3** Select "Shortcut No" **[Change]** or "Shortcut Name" **[Change]** > Change the settings > **[OK]**.
  - 4** **[Save]** > **[Yes]**

## Deleting Shortcuts

- 1** In the setup screen of each function, select **[Add Shortcut]** in the bottom of the screen.
- 2** Delete the shortcut
  - 1** Select **[Edit]**.
  - 2** Select the shortcut key you want to delete > **[Delete this Shortcut]** > **[Yes]**

# 3 Sending Faxes

This chapter explains the following topics:

Basic transmission procedure .....	3-2		
Using redial .....	3-3		
Checking the Send Status .....	3-4		
Priority Override Send .....	3-4		
Cancelling Memory Transmission (while originals are being scanned) ....	3-5		
Cancelling Memory Transmission (during communication) .....	3-5		
Cancelling Transmission (Disconnection of Communication) .....	3-6		
Methods For Entering the Destination .....	3-7		
Entering the destination fax number with the numeric keys .....	3-7		
Choosing from the Address Book .....	3-9		
Choosing from the One Touch Key ....	3-11		
Choosing from the Speed Dial .....	3-11		
Choosing from the Destination History .....	3-12		
Checking and Editing Destinations ...	3-13		
Broadcast Transmission .....	3-14		
Login/Logout .....	3-17		
Logging in when User Login Administration has been Enabled .....	3-17		
Logging in when Job Accounting has been Enabled .....	3-18		
Fax transmission functions .....	3-19		
Original Size .....	3-21		
Mixed Size Originals .....	3-21		
2-sided/Book Original .....	3-22		
Original Orientation .....	3-22		
Sending Size .....	3-23		
Long Original .....	3-23		
Density .....	3-23		
Original Image .....	3-23		
FAX TX Resolution .....	3-24		
Zoom .....	3-24		
Centering .....	3-24		
Border Erase/Full Scan .....	3-25		
FAX Delayed Transmission .....	3-26		
		Setting the Delayed Transmission .....	3-27
		Changing/Deleting Delayed Transmission .....	3-27
		Cancelling Delayed Transmissions (Queued) .....	3-28
		Immediate transmission .....	3-28
		Continuous Scan .....	3-28
		Job Finish Notice .....	3-28
		File Name Entry .....	3-29
		FAX Direct Transmission .....	3-29
		Cancelling Direct Transmission .....	3-29
		Send and Print .....	3-30
		Send and Store .....	3-30
		FAX TX Report .....	3-30
		Manual Send .....	3-31
		Standby Transmission .....	3-32
		Interrupt Send .....	3-33
		Using chain dial .....	3-34
		Using Program .....	3-36



# Basic transmission procedure

The basic procedure for using the fax system is explained below.

## 1 Select [FAX] on the Home screen.

The base screen for fax appears.

## 2 Place the originals.

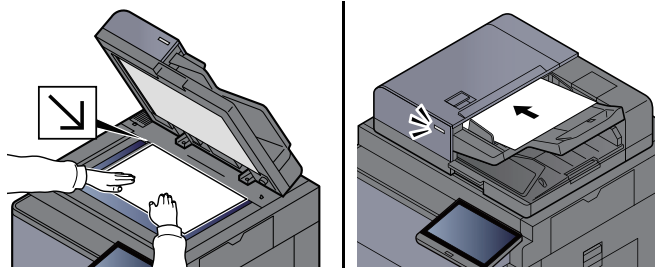

### NOTE

The illustration varies between models.

For placing originals, refer to the following:

- ➔ [Machine's Operation Guide](#)

## 3 Select the transmission method.

There are two transmission methods: memory transmission and direct transmission.

**Memory transmission:** The original is scanned into memory before communication starts. Memory transmission is selected by default.

**Direct transmission:** The destination is dialed and communication starts before the original is scanned.

Select [**Direct**] to change the transmission method to direct transmission. The key will be highlighted on the touch panel. If the [**Direct**] is selected in the highlighted state, the transmission method will change to memory transmission.

- ➔ [FAX Direct Transmission \(page 3-29\)](#)

## 4 Specifying destination.

Specify the transmission destination.

- ➔ [Methods For Entering the Destination \(page 3-7\)](#)

## 5 Selecting the functions.

Select the tab, and set transmitting functions that can be used.

- ➔ [Fax transmission functions \(page 3-19\)](#)

## 6 Send Start.

Press the **[Start]** key.

When scanning finishes, transmission starts.

### When originals are placed in the document processor

After originals placed in the document processor are scanned and stored in the memory, the receiving system is dialed.

### When originals are placed on the glass surface

After originals placed on the glass surface are scanned and stored in the memory, the receiving system is dialed.



#### NOTE

- When continuous scan is set, you can continue with scanning of a next original after an original on the glass surface has been stored in memory. Every time one page is scanned, you perform an operation to allow continued scanning, and after all the originals have been stored in memory, the receiving system is dialed.
- ➔ [Continuous Scan \(page 3-28\)](#)
- If there is no response from the other machine when you attempt to send, the machine will automatically redial (auto redial). You can change the number of auto redial attempts.
- ➔ [Retry Times \(page 8-10\)](#)

## Using redial

Redial is a function allowing you to dial the last entered number once again.

Use this when the receiving system does not respond when you have tried to send a fax. When you want to send the fax to the same receiving system, select **[Recall]**, and you can call the receiving system you dialed on the destination list.

### 1 Select **[Recall]**.

### 2 Press the **[Start]** key.

The transmission will start.



#### NOTE

Recall information is canceled in the following conditions.

- When you turn the power off
- When you send a next fax (new recall information is registered)
- When you log out

## Checking the Send Status

- 1 Select the [Status/Job Cancel] key.**
- 2 Display the send job status screen.**

Select [**Sending Jobs**].  
The list of accepted time, destination, and status are displayed for each job.

## Priority Override Send

A fax job waiting to be sent can be sent by priority override.

- 1 Select the [Status/Job Cancel] key.**
- 2 Select the job to be sent by priority override.**
  - 1 Select [Sending Jobs].**
  - 2 Select the fax job to be sent by priority override and select [Priority Override] > [Yes].**

The selected fax job is sent by priority override and other fax jobs are moved down in the transmission queue.



### NOTE

If a fax job is in progress, the priority override fax job will be sent after the job in progress is completed.

### If a broadcast transmission job is in progress...

If a fax job to multiple destinations (broadcast transmission) is in progress, the priority override job will be sent when transmission to the current destination is completed. When the priority override job is completed, transmission to the remaining destinations will resume.

However, if the priority override job is a broadcast transmission, the priority override job will not start until the current broadcast transmission job is finished.

## Cancelling Memory Transmission (while originals are being scanned)

### 1 Select the **[Stop]** key.

During memory transmission, to cancel scanning while originals are being scanned, select the **[Stop]** key, or select **[Cancel]**.

Scanning of originals is canceled, and the originals are ejected. When originals remain in the document processor, take them out from the original table.

## Cancelling Memory Transmission (during communication)

### NOTE

Even if transmission is canceled, there is a possibility that pages scanned prior to cancelation were sent to the receiving party. Check with the receiving party to see if pages were accidentally sent.

### 1 Select the **[Status/Job Cancel]** key.

### 2 Canceling Transmission.

1 Select **[Sending Jobs]**.

2 Select the transmission job that you want to cancel and select **[Cancel]** > **[Yes]**  
Cancel the transmission.

### NOTE

In some cases, transmission may take place even if the **[Stop]** key or **[Cancel]** is selected.

## Cancelling Transmission (Disconnection of Communication)

Follow this procedure to break the connection and stop communication.

### NOTE

Even if transmission is canceled, there is a possibility that pages scanned prior to cancelation were sent to the receiving party. Check with the receiving party to see if pages were accidentally sent.

When 2 optional FAX Kits (Dual FAX option) are installed, disconnect the line currently being used for communication.

**1** Select the **[Status/Job Cancel]** key.

**2** **Disconnection of communication.**

**[Device/Communicate]** > "FAX Port 1" or "FAX Port 2" **[Line Off]**

### NOTE

To cancel direct transmission, delayed transmission, or polling transmission, refer to the section for that function.

To cancel direct transmission, refer to the following:

➔ [Cancelling Direct Transmission \(page 3-29\)](#)

To cancel a delayed transmission or send a fax by immediate transmission, refer to the following:

➔ [Cancelling Delayed Transmissions \(Queued\) \(page 3-28\)](#)

To cancel polling transmission, refer to the following:

➔ [Polling Reception \(page 5-31\)](#)

# Methods For Entering the Destination

## Entering the destination fax number with the numeric keys

The procedure for entering the destination fax number with the numeric keys is explained below.

 **NOTE**

If **[New Destination Entry(FAX)]** is set to **[Prohibit]**, it is not possible to directly enter a fax number. Select the destination from the Address Book or the One Touch Key.

➔ [New Destination Entry\(FAX\) \(page 8-14\)](#)

- 1** Select **[FAX]** on the Home screen.
- 2** Enter the fax number of the receiving system.

 **NOTE**

Up to 64 digits can be entered.

Use the numeric keys to enter a number.

Key	Description
Pause	Selecting this key adds about three seconds of waiting time during dialing. For example, when dialing the receiving system on an external line, you can use this method to insert a pause before resuming dialing after you dial a specific number.
Space	It is possible to enter half-width spaces in the entry of the destination number. This is useful when checking if the destination number has been entered correctly.
< >	Moves the cursor.
Backspace	To correct the fax number, select <b>[Backspace]</b> on the touch panel, and delete the digits one by one before reentering the fax number. To delete the number entirely, select the <b>[Clear]</b> key on the numeric keys.
On Hook	Select <b>[On Hook]</b> to connect to the telephone line. When the FAX number has been entered, the machine starts dialing to the receiving system. After selecting this key, you can dial the number of the receiving system using the numeric keys.  ➔ <a href="#">Manual Send (page 3-31)</a>

### 3 Select transmission settings.

Select **[Detail]**.

Sub address communication, encrypted transmission, transmission start speed and ECM can be set.

Key	Description
Sub Address	Set this to transmit using a Sub Address. ➔ <a href="#">Sub Address Transmission (page 5-25)</a>
TX Start Speed	This is set to change the transmission start speed. Select the speed from 33,600 bps, 14,400 bps, and 9,600 bps.   <b>NOTE</b> Normally this should be used with the default setting.
ECM	ECM is a communication mode specified by the ITU-T (International Telecommunication Union) that retransmits data when an error occurs. Fax machines that have ECM mode check for errors as they communicate, preventing distortion of the image due to noise on the line and other conditions.
Encrypted Transmission	This is set when using encrypted transmission to send the data. ➔ <a href="#">The fax will be deleted. (page 5-36)</a>

### 4 Select **[OK]**.

Entry of the destination finishes.



#### NOTE

When *On* is selected in *Entry Check for New Dest.*, a confirmation screen is displayed for the entered FAX number. Re-enter the same FAX number and select **[OK]**.

➔ *Machine's Operation Guide*

Select **[FAX Entry]** to enter the next fax number.

➔ [Broadcast Transmission \(page 3-14\)](#)

If **[Broadcast]** is set to **[Prohibit]**, it is not possible to enter multiple destinations.

➔ *Machine's Operation Guide*

In addition to a fax, you can include e-mail transmission and folder (SMB/FTP) transmission to send as one job.

➔ *Machine's Operation Guide*

When  is displayed, you can register entered contents to the Address Book.

## Choosing from the Address Book

Select a destination registered in the Address Book.



### NOTE

For more information about how to register destinations in the Address Book, refer to the following:

➔ [Registering Destinations in the Address Book \(page 2-16\)](#)

## 1 In the basic screen for sending, select [Address Book].



### NOTE

For details on the External Address Book, refer to the following:

➔ *Command Center RX User Guide*

## 2 Select the destinations.

Select the checkbox to select the desired destination from the list. The selected destinations are indicated by a checkmark in the check box. To use an address book on the LDAP server, select "Addr Book" [**Ext Address Book**].

You can change the order in which the destinations are listed by selecting [**Name**] or [**No.**] from the "Sort".



### NOTE

- To deselect, select the checkbox again and remove the checkmark.
- If [Broadcast] is set to [Prohibit], it is not possible to select multiple destinations. Also, it is not possible to select a group that has multiple destinations registered.



## Destination Search

Destinations registered in the Address Book can be searched. Advanced search by type or by initial letter is also available.

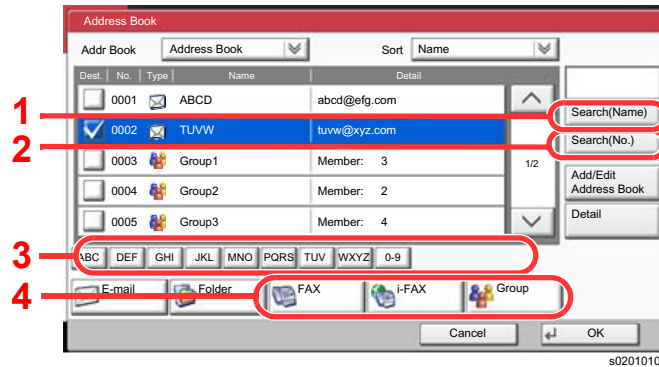

Keys used	Search type	Subjects searched
1	Search by name	Search by registered name.
2	Search by number	Search by registered address number.
3	Advanced search by initial letter	Advanced search by initial letter of registered name.
4	Advanced search by destination	Advanced search by type of registered destination (FAX, i-FAX or Group). (i-FAX: Only when the optional Internet FAX Kit is activated.) You can set this function up so that destination types are selected when the address book is displayed. For details, refer to the following: ➔ <i>Machine's Operation Guide</i>

### 3 Accept the destination > [OK]

Destinations can be changed later.

➔ [Confirmation Screen of Destinations \(page 7-13\)](#)



#### NOTE

To delete the destination, select the destination you want to delete and select **[Delete]**.

You can set the default "Sort" settings.

➔ *Machine's Operation Guide*

## Choosing from the One Touch Key

Select the destination using the One Touch Keys.

In the basic screen for sending, select the One Touch Keys where the destination is registered.

### NOTE

If the One Touch Keys for the desired destination is hidden on the touch panel, select [^] or [v] to scroll and view next or previous One Touch Keys. This procedure assumes that One Touch Keys have already been registered. For more information on adding One Touch keys, refer to the following:

➔ [Adding a Destination on One Touch Key \(page 2-25\)](#)

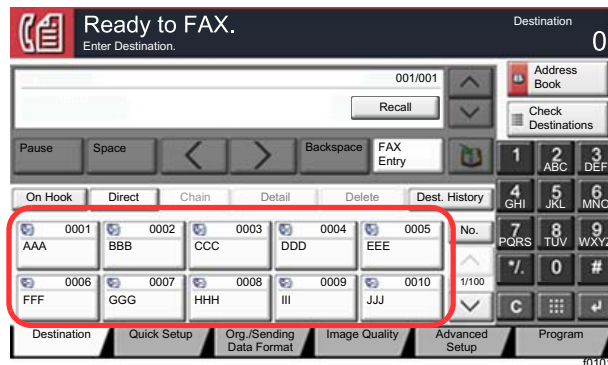

## Choosing from the Speed Dial

Access the destination by specifying the 4-digit (0001 to 1000) One Touch Key number (speed dial).

In the basic screen for sending, select [No.] or the Quick No. Search key on the numeric keypad and use the numeric keys to enter the speed dial number in the numeric entry screen.

### NOTE

If you entered the speed dial in 1 to 3-digit, select [OK].

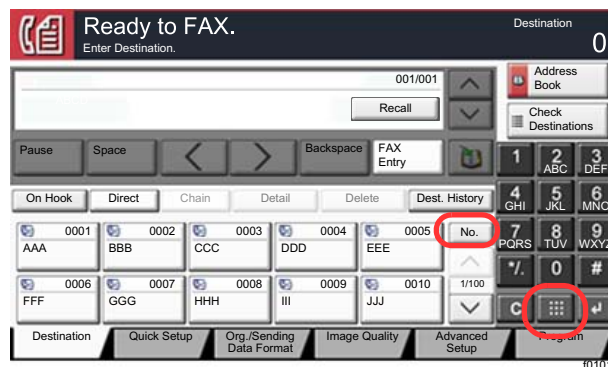

## Choosing from the Destination History

If you send a document with this machine, the address will be saved in the history. You can select an address from the Destination History.

**1** In the basic screen for sending, select **[Dest. History]**.

**2** Select the destinations.

Select an address from the list displayed.

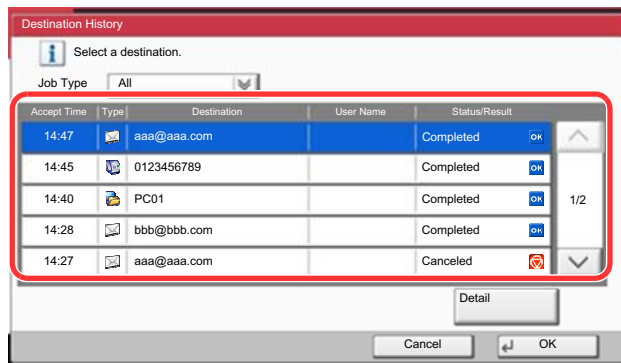

Select [v] of "Job Type" to display only selected type of jobs.

Select **[Detail]** to display the detailed information of the destination.

**3** Select **[OK]**.

## Checking and Editing Destinations

Check and edit a selected destination.

### 1 Display the screen.

Specify the destination.

➔ [Methods For Entering the Destination \(page 3-7\)](#)

### 2 Check and edit the destination.

Select a destination and select **[Detail/Edit]** to check it. The entered addresses can be edited if they have been specified.

Select a destination and select **[Delete]** to remove the destination from the list.



#### NOTE

- When selecting **[On]** for Entry Check for New Destination, the confirmation screen appears. Enter the same FAX No. and sub address again, and select **[OK]**.  
➔ *Machine's Operation Guide*
- When selecting **[On]** for Destination Check before Send, the confirmation screen appears after pressing the **[Start]** key.  
➔ *Machine's Operation Guide*

## Broadcast Transmission

This function allows you to send the same originals to several destinations in one operation. The machine stores (memorizes) originals to send in memory temporarily, and automatically repeats dialing and transmission to the set destination afterwards.

### NOTE

When using a group for the destination, you can send originals to up to 500 destinations in one operation.

You can use this function together with sub address communication and delayed transmission.

When direct transmission has been selected, it changes to memory transmission at the time of transmission.

If [Broadcast] is set to [Prohibit], broadcast transmission is not possible.

➔ *Machine's Operation Guide*

## Sending using FAX Address

**1** Select [FAX] on the Home screen.

**2** Specify the destination.

### Enter the fax number

#### NOTE

If [New Destination Entry(FAX)] is set to [Prohibit], it is not possible to directly enter a fax number. Select the destination from the Address Book or the One Touch Key.

➔ [New Destination Entry\(FAX\) \(page 8-14\)](#)

**1** Enter the fax number of the receiving system.

#### NOTE

Up to 64 digits can be entered.

Use the numeric keys to enter a number.

**2** Select [OK].

#### NOTE

When [On] is selected in [Entry Check for New Dest.], a confirmation screen is displayed for the entered FAX number. Re-enter the same FAX number and select [OK].

➔ *Machine's Operation Guide*

**3** Select [FAX Entry].  
Another fax number can be entered.

**4** When all destinations have been entered, select [OK].

### Select the destination from the Address Book

**1** Select [Address Book].

- 2 Select the checkboxes of all destinations and select **[OK]**.



**NOTE**

For details of the Address Book, refer to the following:

➔ [Choosing from the Address Book \(page 3-9\)](#)

### Select the destination from the One Touch Key

- 1 Select **[One Touch Key]**.
- 2 Select all destinations and select **[OK]**.



**NOTE**

For details of One Touch Key, refer to the following:

➔ [Choosing from the One Touch Key \(page 3-11\)](#)

- 3 After selecting all the destinations, press the **[Start]** key.

### Sending using I-FAX Address



**NOTE**

For more information on sending an Internet FAX (i-FAX), refer to the following:

➔ [Internet Faxing \(i-FAX\) \(page 10-1\)](#)

- 1 Select **[Send]** on the Home screen.
- 2 Specify the destination.

#### Enter the i-FAX address

- 1 Select **[i-FAX Address Entry]**.
- 2 Select **[i-FAX Address]** > Enter the i-FAX address > **[OK]** > **[OK]**
- 3 To continue entering a new address, select **[i-FAX Address Entry]** and repeat the above procedure.
- 4 When all destinations have been entered, select **[OK]**.

#### Select the destination from the Address Book

- 1 Select **[Address Book]**.
- 2 Select the checkboxes of all destinations and select **[OK]**.



**NOTE**

For details of the Address Book, refer to the following:

➔ [Choosing from the Address Book \(page 3-9\)](#)

## Select the destination from the One Touch Key

- 1 Select [**One Touch Key**].
- 2 Select all destinations and select [**OK**].



### NOTE

For details of One Touch Key, refer to the following:

➔ [Choosing from the One Touch Key \(page 3-11\)](#)

- 3 **After selecting all the destinations, press the [Start] key.**

# Login/Logout

## Logging in when User Login Administration has been Enabled

When user login administration has been enabled, you need to enter a User ID and Password to use the machine.

### Normal login

#### 1 Enter the login user name and login password to login.

- 1 If this screen is displayed during operations, select **[Login User Name]** to enter the login user name.

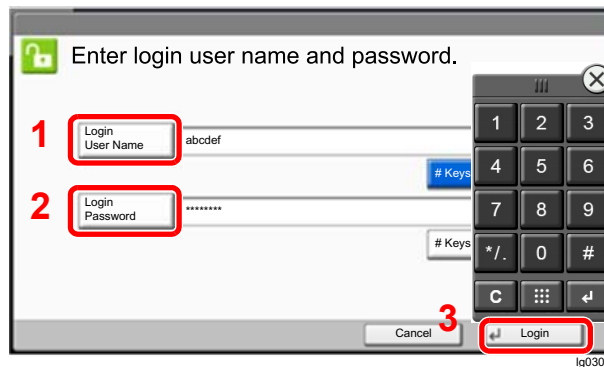

➔ [Character Entry Method \(page 12-2\)](#)

- 2 **[Login Password]** > Enter the login password > **[OK]**

#### NOTE

- When **[# Keys]** is selected, it is possible to enter numbers using the numeric keys.
- If **[Network Authentication]** is selected as the user authentication method, authentication destinations are displayed and either **[Local]** or **[Network]** can be selected as the authentication destination.
- To authenticate by ID card, select **[ID Card Login]**.

#### 2 Select **[Login]**.

### Simple Login

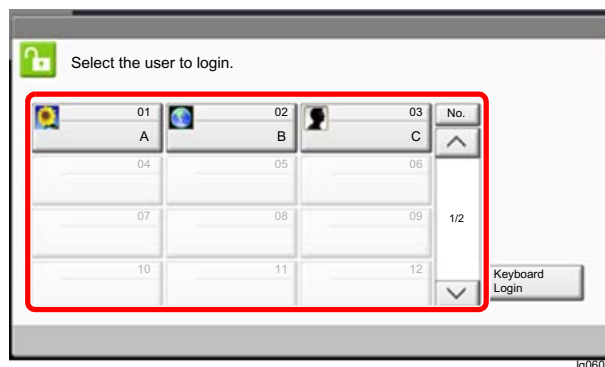

If this screen is displayed during operations, select a user and log in.

#### NOTE

If a user password is required, an input screen will be displayed.

➔ [Machine's Operation Guide](#)



## Logout

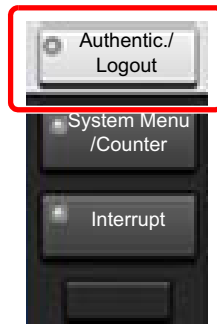

To logout from the machine, select the **[Authentication/Logout]** key to return to the login user name/login password entry screen.

## Logging in when Job Accounting has been Enabled

When job accounting has been enabled, you need to enter an Account ID when using the machine.

### Login

- 1 In the account ID entry screen, enter the account ID using the numeric keys and select **[Login]**.

#### NOTE

- If you entered a wrong character, select the **[Clear]** key and enter the account ID again.
- If the entered account ID does not match the registered ID, a warning beep will sound and login will fail. Enter the correct account ID.
- By selecting **[Check Counter]**, you can refer to the number of pages printed and the number of pages scanned.

#### **When the screen to enter the login user name and password appears**

If user login administration is enabled, the screen to enter the login user name and password appears. Enter a login user name and password to login. If the user has already registered the account information, the account ID entry would be skipped.

➔ Machine's *Operation Guide*

- 2 Proceed to complete the rest of the steps.

### Logout

When the operations are complete, select the **[Authentication/Logout]** key to return to the account ID entry screen.

# Fax transmission functions

To configure the settings for functions, select the tab and select the function key.

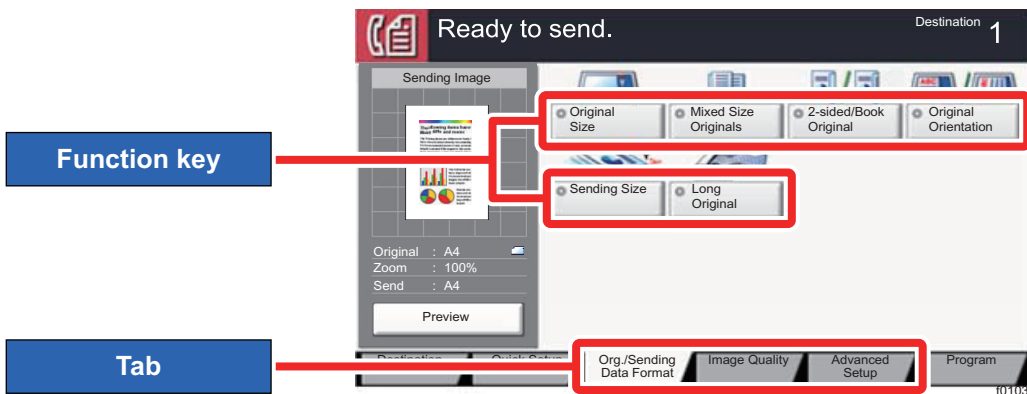

For details on each function, see the table below.

Tab	Function key	Description	Reference page
<p><b>Org./Sending Data Format</b></p> <p>Configure the settings for original size and type.</p>	<b>Original Size</b>	Specify the original size to be scanned.	<a href="#">3-21</a>
	<b>Mixed Size Originals</b>	Scan the documents of different sizes that are set in the document processor all at once.	<a href="#">3-21</a>
	<b>2-sided/Book Original</b>	Select the type and orientation of the binding based on the original.	<a href="#">3-22</a>
	<b>Original Orientation</b>	Select the orientation of the original document top edge to scan correct direction.	<a href="#">3-22</a>
	<b>Sending Size</b>	Select size of image to be sent.	<a href="#">3-23</a>
	<b>Long Original</b>	Reads long-sized original documents using a document processor.	<a href="#">3-23</a>
<p><b>Image Quality</b></p> <p>Configure the settings for density, and quality of copies.</p>	<b>Density</b>	Adjust density.	<a href="#">3-23</a>
	<b>Original Image</b>	Select original image type for best results.	<a href="#">3-23</a>
	<b>FAX TX Resolution</b>	Select fineness of images when sending FAX.	<a href="#">3-24</a>

Tab
<div style="border: 1px solid #ccc; padding: 5px; width: fit-content; margin-bottom: 10px;"> <p style="text-align: center;">Advanced Setup</p> </div> <p>Configure settings such as send and print, delayed transmission and polling reception.</p>



Function key	Description	Reference page
<b>Zoom</b>	Scan originals by automatically zooming them according to the sending size.	<a href="#">3-24</a>
<b>Centering</b>	Centers the original image on the paper when copying onto paper different from the original size.	<a href="#">3-24</a>
<b>Border Erase/Full Scan</b>	Erases the black border that forms around the image.	<a href="#">3-25</a>
<b>FAX Delayed Transmission</b>	Set a send time.	<a href="#">3-26</a>
<b>Continuous Scan</b>	Scans a large number of originals in separate batches and then produce as one job.	<a href="#">3-28</a>
<b>Job Finish Notice</b>	Sends E-mail notice when a job is complete.	<a href="#">3-28</a>
<b>File Name Entry</b>	Adds a file name.	<a href="#">3-29</a>
<b>FAX Direct Transmission</b>	Sends FAX directly without reading original data into memory.	<a href="#">3-29</a>
<b>FAX Polling RX</b>	Dial the destination and receive documents for Polling Transmission stored in the polling box.	<a href="#">5-32</a>
<b>Send and Print</b>	Allows you to print a copy of the document being sent.	<a href="#">3-30</a>
<b>Send and Store</b>	Allows you to store a copy of the document being sent in a Custom Box.	<a href="#">3-30</a>
<b>FAX TX Report</b>	Print a report of FAX transmission results.	<a href="#">3-30</a>

# Original Size

Specify the original size to be scanned.

Select [**Standard Sizes 1**], [**Standard Sizes 2**], [**Others**] or [**Size Entry**] to select the original size.

Item	Value	Description
<b>Standard Sizes 1</b>	Metric models: Auto, A3, A4-R, A4, A5-R, A5, A6-R, B4, B5, B5-R, B6-R, B6, Folio, 216×340 mm  Inch models: Auto, Ledger, Letter-R, Letter, Legal, Statement-R, Statement, 11×15", Oficio II	Have the size of original detected automatically, or select from the standard sizes.
<b>Standard Sizes 2</b>	Metric models: Ledger, Letter-R, Letter, Legal, Statement-R, Statement, 11×15", Oficio II, 8K, 16K-R, 16K  Inch models: A3, A4-R, A4, A5-R, A5, A6-R, B4, B5-R, B5, B6-R, B6, Folio, 8K, 16K-R, 16K, 216×340 mm	Select from standard sizes except Standard Sizes 1.
<b>Others</b>	Hagaki(Cardstock), Oufuku hagaki(Return postcard), Custom* <sup>1</sup>	Select from special standard sizes and custom sizes.
<b>Size Entry</b>	Metric X: 50 to 432 mm (in 1 mm increments) Y: 50 to 297 mm (in 1 mm increments)  Inch X: 2.00 to 17.00" (in 0.01" increments) Y: 2.00 to 11.69" (in 0.01" increments)	Enter the size not included in the standard sizes 1 and 2.* <sup>2</sup>  When you have selected [ <b>Size Entry</b> ], select [ <b>+</b> ] or [ <b>-</b> ] to set the sizes of "X" (horizontal) and "Y" (vertical). Select [ <b># Keys</b> ] to use the numeric keys for entry.

\*1 For instructions on how to specify the custom original size, refer to the following:

➔ Machine's *Operation Guide*

\*2 The input units can be changed in System Menu. For details, refer to the following:

➔ Machine's *Operation Guide*



**NOTE**

Be sure to always specify the original size when using custom size originals.

# Mixed Size Originals

Scan the documents of different sizes that are set in the document processor all at once. Different Width is not displayed in inch models.

Item	Value	Description
<b>Mixed Size Originals</b>	<b>Off</b>	
	Same Width	Scans and sends multiple sheets of the same width using the document processor.
	Different Width	Scans and sends multiple sheets of different width using the document processor.

**NOTE**

If the document processor is option, it is required to install the document processor for use of this function.

## 2-sided/Book Original

Select the type and orientation of the binding based on the original.

Item		Value	Description
1-sided		—	"2-sided/Book Original" is not set.
2-sided* <sup>1</sup>	Binding	Binding Left/ Right, Binding Top	Select the binding orientation of originals.
	Original Orientation	Top Edge on Top, Top Edge on Left	Select the orientation of the original document top edge to scan correct direction. Select [ <b>Original Orientation</b> ] to choose orientation of the originals, either [ <b>Top Edge on Top</b> ] or [ <b>Top Edge on Left</b> ]. Then select [ <b>OK</b> ].
Book* <sup>2</sup>	Binding	Binding Left, Binding Right	Select the binding orientation of originals.

\*1 If the document process is option, [**2-sided**] will be displayed once document processor is installed.

\*2 [**Top Edge on Top**] is set for "Original Orientation".

## Original Orientation

To scan the original in the correct orientation, specify which side of the original is the top. To set a 2-sided original, the orientation of the placed original must be set.

Select original orientation from [**Top Edge on Top**], [**Top Edge on Left**] or [**Auto**].

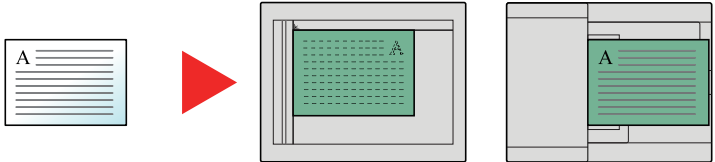
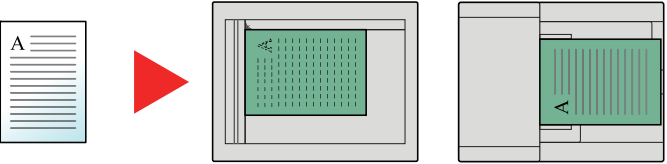
Item	Image
Top Edge on Top	 <p>Original                      Original orientation</p>
Top Edge on Left	 <p>Original                      Original orientation</p>

## Sending Size

Select size of image to be sent.

Item	Value	Description
<b>Standard Sizes 1</b>	Metric models: Same as Original Size, A3, A4, A5, A6, B4, B5, B6, Folio, 216×340 mm Inch models: Same as Original Size, Ledger, Letter, Legal, Statement, 11×15", Oficio II	Select from Same as Original Size or Standard Size.
<b>Standard Sizes 2</b>	Metric models: Ledger, Letter, Legal, Statement, 11×15", Oficio II, 8K, 16K Inch models: A3, A4, A5, A6, B4, B5, B6, Folio, 8K, 16K, 216×340 mm	Select from standard sizes except Standard Sizes 1.
<b>Others</b>	Hagaki(Cardstock), Oufuku hagaki(Return postcard)	Select from Hagaki(Cardstock).

## Long Original

Reads long-sized original documents using a document processor.

(Value: [Off] / [On])



### NOTE

Only a single side of a long original can be scanned.

Originals of up to 1,600 mm/63" long can be scanned.

If the document processor is option, it is required to install the document processor for use of this function.

## Density

Adjust density.

(Value: [-4] (Lighter) to [+4] (Darker))

## Original Image

Select original image type for best results.

Item	Description
<b>Text+Photo</b>	Best for mixed text and photo documents.
<b>Photo</b>	Best for photos taken with a camera.
<b>Text</b>	Sharply renders pencil text and fine lines. Select [Text], [Text (Fine Line)] or [Text (OCR)].

## FAX TX Resolution

Select fineness of images when sending FAX. The larger the number, the better the image resolution. However, better resolution also means larger file sizes and longer send times.

Item	Description	
600 × 600 dpi	when sending originals with minute characters and lines as finely as possible	Typical character size: 6 point (example: Resolution Resolution)
400x400dpi Ultra Fine	when sending originals with minute characters and lines more finely	Typical character size: 6 point (example: Resolution Resolution)
200x400dpi Super Fine	when sending originals with minute characters and lines	Typical character size: 6 point (example: Resolution Resolution)
200 × 200 dpi Fine	when sending originals with relatively small characters and thin lines	Typical character size: 8 point (example: Resolution Resolution)
200 × 100 dpi Normal	when sending originals with standard size characters	Typical character size: 10.5 point (example: Resolution Resolution)



### NOTE

The default setting is [200 × 100 dpi Normal]. The higher the resolution, the clearer the image, but the fax transmission time is longer.

## Zoom

Scan originals by automatically zooming them according to the sending size.

(Value: [100%] / [Auto])



### NOTE

If the original is scanned at full size, the image may be reduced if a smaller paper size is set on the receiving machine.

## Centering

When you have sent/stored the original after specifying the original size and sending size, depending on these sizes, a margin is created at the bottom, left, or right side of paper. By using the Centering function, the image is placed with a margin equally created for all edges.

(Value: [Off] / [On])

## Border Erase/Full Scan

Erases the black border that forms around the image. The following modes are available.

Item		Value	Description
Standard		Read the source document with Standard Mode. (Border Erase Width: 2 mm)	
Full Scan		Scan without erasing borders around the original.	
Border Erase Sheet	Border	Metric: 0 mm to 50 mm (in 1 mm increments) Inch: 0.00 to 2.00" (in 0.01" increments)	Set the border erase width.* <sup>1</sup> Set the value by selecting [+] or [-]. Select [ <b># Keys</b> ] to use the numeric keys for entry.
	Back Page	Same as Front Page, Do Not Erase	For 2-sided originals, select [ <b>Back Page</b> ] and then select [ <b>Same as Front Page</b> ] or [ <b>Do Not Erase</b> ].
Border Erase Book	Border	Metric: 0 mm to 50 mm (in 1 mm increments)	Set the border erase width.* <sup>1</sup> Set the value by selecting [+] or [-]. Select [ <b># Keys</b> ] to use the numeric keys for entry.
	Gutter	Inch: 0.00 to 2.00" (in 0.01" increments)	
	Back Page	Same as Front Page, Do Not Erase	For 2-sided originals, select [ <b>Back Page</b> ] and then select [ <b>Same as Front Page</b> ] or [ <b>Do Not Erase</b> ].
Individual Border Erase	Top	Metric: 0 mm to 50 mm (in 1 mm increments) Inch: 0.00 to 2.00" (in 0.01" increments)	Set the border erase width.* <sup>1</sup> Set the value by selecting [+] or [-]. Select [ <b># Keys</b> ] to use the numeric keys for entry.
	Bottom		
	Left		
	Right		
	Back Page	Same as Front Page, Do Not Erase	For 2-sided originals, select [ <b>Back Page</b> ] and then select [ <b>Same as Front Page</b> ] or [ <b>Do Not Erase</b> ].
	Original Orientation	Top Edge on Top, Top Edge on Left	Select the orientation of the original document top edge to scan correct direction. Select [ <b>Original Orientation</b> ] to choose orientation of the originals, either [ <b>Top Edge on Top</b> ] or [ <b>Top Edge on Left</b> ]. Then select [ <b>OK</b> ].

\*1 The input units can be changed in System Menu.

➔ *Machine's Operation Guide*



# FAX Delayed Transmission

Set a send time. You can use delayed transmission together with the broadcast transmission function, etc.

Item	Description
Off	Does not use the delayed transmission.
On	Uses the delayed transmission.
Start Time	Set the time from between 00:00 and 23:59 in one-minute increments.

 **IMPORTANT**  
**If the current time displayed on the touch panel is not correct, you cannot send originals correctly at the preset time. In this case, adjust the time.**  
 ➔ [Setting Date and Time \(page 2-15\)](#)

 **NOTE**  
 You cannot select direct transmission.  
 You can set up to 200 destinations for delayed transmission.  
 When two or more delayed transmissions are set for the same time, the communication will start in the order that the delayed transmissions have been set. When delayed transmissions have been set in reverse order, however, sending of originals to be sent to the same destination is prioritized over the ones to be sent to different destinations.  
 You can cancel a delayed transmission any time before the specified transmission time. You can also send a delayed transmission before the specified time.  
 ➔ [Cancelling Delayed Transmissions \(Queued\) \(page 3-28\)](#)  
 You can change destinations of a delayed transmission any time before the specified transmission time.  
 ➔ [Changing/Deleting Delayed Transmission \(page 3-27\)](#)  
 If you use delayed transmission when sending documents stored in the Custom Box by fax, you cannot move documents until sending is finished.  
 ➔ [Machine's Operation Guide](#)

## Batch Transmission Function

When fax originals to be sent to the same destination are set to the same transmission start time with delayed transmission, you can send up to 10 groups of originals using batch transmission. This function prevents repeated communication to the same destination and reduces the communication cost.

 **NOTE**  
 You cannot send originals as a batch transmission in the case of direct transmission.  
 In the case of broadcast transmission, when you have set two or more groups of originals to the same transmission start time, and each group includes the same receiving system fax number, you cannot send the originals as a batch transmission.  
 When the transmission start time has come, and there are fax originals waiting for redial to the same receiving system, the waiting originals are also sent together as a batch transmission.  
 When job accounting is ON, only the originals with the same account ID set using delayed transmission are sent as a batch transmission.

# Setting the Delayed Transmission

## Changing/Deleting Delayed Transmission

You can change or delete the destinations of delayed transmission.

Use the procedure below to check a job's information.

### 1 Display the screen.

- 1 [Status/Job Cancel] key > [Sending Jobs] > [Scheduled Job]
- 2 Select the job you want to change or delete from the list > [Detail]  
Detailed information of the selected job is displayed.
- 3 Select [Detail/Edit] in "Status/Destination".

### 2 Changing.

#### When adding another destination

- 1 Select the address to be added from the Address Book or enter the fax number using the numeric keys.

#### When selecting [Address Book]

Select the destination you want to change in the list > [OK]

#### When entering the fax number using the numeric keys

Enter the fax number using the numeric keys > [OK]

- 2 Select [OK].

#### NOTE

When *On* is selected in *Entry Check for New Dest.*, a confirmation screen is displayed for the entered FAX number. Re-enter the same FAX number and select [OK].

➔ *Machine's Operation Guide*

When [New Destination Entry(FAX)] is set to [Prohibit], the numeric keys cannot be used to enter a fax number.

➔ [New Destination Entry\(FAX\) \(page 8-14\)](#)

#### When changing the destination to another destination

- 1 Select the destination you want to change > [Detail/Edit]  
You can change the selected destination.
- 2 Select [OK].

#### When deleting the destination

Select the destination you want to delete > [Delete] > [OK]

## Cancelling Delayed Transmissions (Queued)

To cancel delayed transmissions that are queued, use the procedure below.

- 1 Display the screen.**  
[Status/Job Cancel] key > [Sending Jobs] > [Scheduled Job]
- 2 Canceling a job.**  
Select the job you want to cancel and select [Cancel] > [Yes].  
The selected job is deleted.

## Immediate transmission

To send delayed transmissions immediately rather than waiting for the specified time, use the procedure below.

- 1 Display the screen.**  
[Status/Job Cancel] key > [Sending Jobs] > [Scheduled Job]
- 2 Immediate transmission.**  
Select the job you want to send by immediate transmission, and select [Start Now] > [Yes].  
The transmission will start.

## Continuous Scan

Scans a large number of originals in separate batches and then produce as one job.

Originals will be scanned continuously until you select [Finish Scan].

You can set the functions that appear on the screen during scanning.

(Value: [Off] / [On])



### NOTE

When scanning and sending source documents on the platen, you can always set Continuous Scan.

➔ [Always Cont Scan w/Platen \(page 8-11\)](#)

## Job Finish Notice

Sends E-mail notice when a job is complete. It is also available that send a notice when a job is interrupted.

Users can be notified of the completion of a job while working at a remote desk, saving the time spent waiting beside the machine to finish.



### NOTE

PC should be configured in advance so that E-mail can be used.

➔ *Machine's Operation Guide*

E-mail can be sent to a single destination.

It is possible to attach an image to the e-mail notice.

➔ [Job Finish Notice Setting \(page 8-15\)](#)

## File Name Entry

Adds a file name.

Additional information such as job number and date and time can also be set. You can check a job history or job status using the file name, date and time, or job number specified here.

Select [**File Name**], enter the file name (up to 32 characters), and select [**OK**].

To add date and time, select [**Date and Time**]. To add job number, select [**Job No.**]. The added information will be displayed in "Additional Info".

## FAX Direct Transmission

The destination is dialed and communication starts before the original is scanned, allowing you to verify that each page of the fax has been properly sent.

Setting for Direct transmission	Description
On	Starts direct transmission. Dials the receiving system, and after the communication has started, originals are scanned.
Off	Starts memory transmission. After originals are scanned into memory, the communication starts.



### NOTE

In direct transmission, you can designate only one destination for one transmission.

In the basic screen for sending, select [**Direct**]. This selects the direct transmission method and the keys on the touch panel are highlighted.

## Cancelling Direct Transmission

During direct transmission, to cancel communication during transmission, select the [**Stop**] key or [**Cancel**]. The originals that have been scanned are ejected, and the screen returns to the send default screen. When originals remain in the document processor, take them out.



### NOTE

In some cases, transmission may take place even if the [**Stop**] key or [**Cancel**] is selected.

## Send and Print

Prints a copy of the document being sent.

Item	Description
Off	Does not print a copy of the document being sent.
On	Prints a copy of the document being sent.

## Send and Store

Stores a copy of the document being sent in a Custom Box.

Item	Description
Off	Does not store a copy of the document being sent in a Custom Box.
On	Store a copy of the document being sent in a Custom Box.



### NOTE

When [**On**] is selected, select the Custom Box in which the copy is to be stored.

If a password entry screen for the Custom Box appears, enter the password.

You can view information on the selected Custom Box by selecting [**Detail**].

## FAX TX Report

You can check whether FAX was transmitted properly by printing the report after transmission.

Item	Description
Off	Does not print reports.
On	Prints reports.
Error Only	Prints reports only if an error occurs.



### NOTE

This setting is displayed if FAX TX Result Reports is set to [**Specify Each Job**].

➔ [Send Result Reports \(page 7-7\)](#)

# Manual Send

This method allows you to send originals by pressing the **[Start]** key after confirming that the telephone line has connected to the receiving system.

 **NOTE**  
Connecting a telephone set (commercially available product) to this machine enables you to talk with the person at the receiving system before sending originals.

➔ [Manual Send \(page 5-47\)](#)

- 1** Select **[FAX]** on the Home screen.
- 2** Place the originals.
- 3** Select **[On Hook]**.
- 4** Use the numeric keys to enter the number of the receiving system.

 **NOTE**  
To cancel the operation, select **[Line Off]**.

- 5** Press the **[Start]** key.  
When you hear the fax tone, the telephone line has connected to the receiving system. Press the **[Start]** key. Transmission begins.

# Standby Transmission

During a communication, you can scan originals and schedule a next transmission. When the first communication is completed, the machine automatically starts the scheduled next transmission. When using standby transmission, you do not need to wait when a communication has prolonged due to broadcast transmission.



## NOTE

Together with delayed transmission and interrupt send, up to 210 transmissions can be scheduled. You can use the broadcast transmission function.

- 1 Select [FAX] on the Home screen.**
- 2 Place the originals.**
- 3 Select the destination, and set transmitting functions if you want to use any.**
- 4 Press the [Start] key.**

Scanning of the originals starts, and the next transmission is scheduled.



## NOTE

When [On] is selected in [Dest. Check before Send], a destination confirmation screen is displayed when you press the [Start] key.

➔ [Confirmation Screen of Destinations \(page 7-13\)](#)

- 5 When the communication is completed, the scheduled transmission will begin.**

# Interrupt Send

During communication, when you scan originals by selecting direct transmission, you can use interrupt send. Even when the communication is prolonged due to broadcast transmission or a next transmission being scheduled, the machine will first send originals for which interrupt send has been set.

 **NOTE**  
When the total number of standby transmissions and delayed transmissions has already reached 210, you cannot use interrupt send.

- 1 Select [FAX] on the Home screen.**
- 2 Load the originals to be sent using Interrupt Send.**
- 3 Select [Direct].**

For operation of direct transmission, refer to the following:

➔ [FAX Direct Transmission \(page 3-29\)](#)

- 4 Set the destination, and press the [Start] key.**

The originals are left in queue, and the transmission will start when transmission becomes possible.

 **NOTE**  
When [On] is selected in [Dest. Check before Send], a destination confirmation screen is displayed when you press the [Start] key.

➔ [Confirmation Screen of Destinations \(page 7-13\)](#)

To cancel transmission while waiting for interrupt send, select the [Stop] key or [Cancel].

➔ [Cancelling Direct Transmission \(page 3-29\)](#)

- 5 When the interrupt send is completed, the waiting communication and standby transmission will automatically resume.**



# Using chain dial

Chain dial is a function that allows you to dial by linking fax numbers of the receiving systems with a chain number created with a number common to several destinations.

By setting multiple phone numbers from several telephone companies to a chain number, you can later choose the one that costs the least to send the fax to a remote or international destination.

## NOTE

It is convenient to register chain numbers that are used frequently to the Address Book or One Touch Key.

For registration to the Address Book, refer to the following:

➔ [Adding a Destination \(Address Book\) \(page 2-16\)](#)

For registration to One Touch Key, refer to the following:

➔ [Adding a Destination on One Touch Key \(page 2-25\)](#)

As an example, when using '212' as the chain number

## 1 Select the chain dial number

To use a One Touch Key, select the destination in which "212" is registered.

## NOTE

To use the Address Book, select the destination in which "212" is registered as explained in Choosing from the Address Book.

➔ [Choosing from the Address Book \(page 3-9\)](#)

To enter using the numeric keys, enter "212".

## 2 Select [Chain].

## 3 Enter the fax number to be added to the chain number.

### Select fax number from the Address Book

#### 1 Select [Address Book].

Multiple destinations can be selected.

#### 2 When [OK] is selected, "212" is automatically added to all destinations.

For the procedure for selecting a destination in the address book, refer to the following:

➔ [Choosing from the Address Book \(page 3-9\)](#)

### Select fax number from One Touch Key

#### 1 Select [One Touch].

#### 2 When [OK] is selected, "212" is automatically added.

## Use the numeric keys to enter a fax number

- 1 Enter the fax number.
- 2 Select **[OK]**.  
When **[OK]** is selected, "212" is automatically added.



### NOTE

When **[On]** is selected in **[Entry Check for New Dest.]**, a confirmation screen is displayed for the entered FAX number. Re-enter the same FAX number and select **[OK]**.

➔ *Machine's Operation Guide*

# Using Program

A destination, transmission time, and other transmission settings can be registered as a program. After a program has been registered, it can be opened by simply selecting it from the Program screen.

For the procedure for registering a program, refer to the following:

➔ Machine's *Operation Guide*

## 1 Recall the program.

- 1 Select **[Program]** in the Home screen, or the key of the registered program.

Selecting the key of the registered program will recall the program. If you selected **[Program]**, proceed to step 1-2.

- 2 Select the key for the program number you want to recall.

Select **[No.]** or the Quick No. Search key on the numeric keypad to enter the program number (01 to 50) directly for recalling.

### NOTE

If the program cannot be recalled, the Document Box or the form overlay specified in the program might have been deleted. Check the Document Box.

## 2 Execute the program.

Place the originals > **[Start]** key

### NOTE

**[Program]** can be pressed in each function to call up the program registered for the function.

# 4 Receiving Faxes

This chapter explains the following topics:

FAX Reception .....	4-2
Reception Method .....	4-2
Set the Reception Method .....	4-2
Automatic Reception .....	4-3
Flow of automatic reception .....	4-3
Canceling reception (Disconnection of communication) .....	4-3
Manual Reception .....	4-4
Flow of manual reception .....	4-4
Fax reception functions .....	4-5
Media Type for Print Output .....	4-6
FAX Exclusive Paper Source .....	4-7
Multipurpose Tray .....	4-7
Reduced RX Size .....	4-7
Reception Date/Time .....	4-8
Duplex Printing .....	4-8
2 in 1 Print .....	4-8

# FAX Reception

When using this machine as a FAX-dedicated machine that does not receive telephone calls, set the machine to automatic reception. No special operation is required when receiving faxes.

## Reception Method

The methods for receiving faxes on the machine are shown below.

- Auto (Normal)
- Auto (FAX/TEL) (Refer to [5-41.](#))
- Auto (Answering machine) (Refer to [5-43.](#))
- Manual (Refer to [4-4.](#))
- Auto (DRD) (Available for some countries.) (Refer to [5-45.](#))

## Set the Reception Method

### **1** Display the screen.

[System Menu/Counter] key > **[FAX]** > "Reception" **[Next]** > "FAX" **[Next]** > "RX Setting" **[Change]**

### **2** Select the reception method.

Select the reception method > **[OK]**

For Automatic Reception, select **[Auto (Normal)]**.

# Automatic Reception

## Flow of automatic reception

### 1 Reception Starts

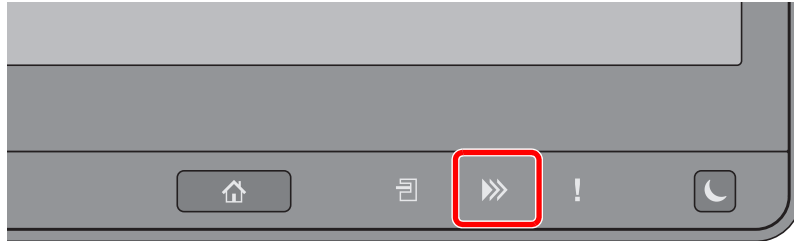

When a fax comes in, the **[Data]** (»») indicator blinks and reception automatically begins.



#### NOTE

When a telephone (commercially available product) is connected to the machine, reception starts after the telephone rings.

You can change the number of times the ringing tone rings.

➔ [FAX \(page 8-9\)](#)

#### Memory Reception

When the machine cannot print a fax due to paper running out or a paper jams, it temporarily stores originals that have been sent in the image memory. When the machine returns to the printable state, printing starts.

The number of pages that can be stored depends on the pages. As a general guideline, about 7,000 or more A4 size pages at normal resolution can be stored.

During memory reception, FAX Reception Printing Jobs are displayed on Printing Jobs of the Status screen. To print the received originals, supply paper or remove jammed paper.

For the Status screen, refer to the following:

➔ *Machine's Operation Guide*

### 2 Reception Print

Received faxes are output to the inner tray with the printed side facing down.

## Canceling reception (Disconnection of communication)

When you cancel receiving by disconnecting the telephone line during communication, use the following procedure.

#### 1 Select the **[Status/Job Cancel]** key.

#### 2 Disconnection of communication.

**[Device/Communicate]** > "FAX Port 1" or "FAX Port 2" **[Line Off]**

When communication is disconnected, reception stops.

# Manual Reception

This method allows you to receive faxes by selecting [**Manual RX**] after confirming that the telephone line has connected to the sending system.

 **NOTE**

To use Manual Reception, you need to change the receiving mode to Manual Reception. To change to manual mode, refer to the following:

➔ [RX Setting \(page 8-13\)](#)

Connecting a telephone set (commercially available product) to this machine enables you to receive originals after talking to the person at the sending system.

➔ [Manual Reception \(page 5-48\)](#)

## Flow of manual reception

- 1 The machine receives a call.**  
When the machine receives a call, it rings.
- 2 Select [FAX] on the Home screen.**
- 3 Select [On Hook].**  
Select [**On Hook**] to establish the connection.
- 4 Select [Manual RX].**  
Reception will start.

## Fax reception functions

The reception method and fax printing method can be set.

What do you want to do?	Reference Page
Restrict the type of paper that can be used.	Media Type for Print Output ▶ page 4-6
When you want to restrict the type of cassette that can be used.	FAX Exclusive Paper Source ▶ page 4-7
You can select whether to use the MP tray paper when printing out the received fax.	Multipurpose Tray ▶ page 4-7
When the reception size is larger than the paper size, you can reduce the print size.	Reduced RX Size ▶ page 4-7
Print the date and time of reception and other information.	Reception Date/Time ▶ page 4-8
Print received faxes on both sides of the paper.	Duplex Printing ▶ page 4-8
Receive a two-page fax on one page.	2 in 1 Print ▶ page 4-8
Forward received faxes to another fax machine or a computer.	Memory Forwarding ▶ page 5-2
Store received faxes in the machine without printing them.	FAX Box Function ▶ page 5-17
Initiate reception of a fax by controlling the receiving machine.	Polling Communication ▶ page 5-28
Encrypt an original to send it safely.	The fax will be deleted. ▶ page 5-36



# Media Type for Print Output

Specify the paper type to be used for print output of the received fax.

Supported paper types	All Media Types, Plain, Rough, Vellum, Labels, Recycled, Bond, Cardstock, Color, Envelope, Thick, Coated, High Quality, Custom 1-8
-----------------------	--

For more information about configuring settings, refer to the following:

➔ [Media Type \(page 8-12\)](#)



## NOTE

If FAX exclusive paper source is set, paper is fed from the cassette set as the FAX exclusive paper source.

➔ [FAX Exclusive Paper Source \(page 4-7\)](#)

## Setting the cassette for the print output of received faxes

By specifying the media type, faxes can be received on the corresponding cassette.

### 1 Display the screen.

[System Menu/Counter] key > **[Cassette/MP Tray Settings]**

> "Cassette1-7"<sup>\*1</sup> or "MP Tray Setting" **[Next]**

Select the cassette that you want to use for fax reception.

\*1 The cassette tray displayed varies depending on the installation status of the optional paper feeder.

### 2 Selecting the paper size.

1 Select "Paper Size" **[Change]**.

2 Inch models: **[Auto]** > **[Inch]**  
Metric models: **[Auto]** > **[Metric]**



## IMPORTANT

**Specify the settings as follows for the cassette that you want to use for fax reception.**

**Inch models: [Auto] > [Inch]**

**Metric models: [Auto] > [Metric]**

3 Select **[OK]**.

### 3 Selecting the paper type.

1 Select "Media Type" **[Change]**.

2 Select the paper type.

3 Select **[OK]**.

### 4 Set the paper type.

Configure paper settings for fax reception. When selecting the paper type, select the same paper type as you selected in step 3.

For more information about configuring settings, refer to the following:

➔ [Media Type \(page 8-12\)](#)

## FAX Exclusive Paper Source

Set fax exclusive paper cassettes.

Selectable paper source	Cassette 1 to 7 <sup>*1</sup>
-------------------------	-------------------------------

\*1 The cassette tray displayed varies depending on the installation status of the optional paper feeder.



### NOTE

Cannot select the cassettes below.

- Paper Size is set to other than Auto.
- Media Type is set to Preprinted, Prepunched, Letterhead.

For FAX related reports, paper is fed from the cassette set as the FAX exclusive paper source.

For more information about configuring settings, refer to the following:

➔ [FAX Exclusive Paper Source \(page 8-12\)](#)

## Multipurpose Tray

You can select whether to use the MP tray paper when printing out the received fax.

On	Use the MP tray paper.
Off	Do not use the MP tray paper.

For more information about configuring settings, refer to the following:

➔ [Multipurpose Tray \(page 8-12\)](#)

## Reduced RX Size

When the reception size is larger than the paper size, you can reduce the print size.

On	Print the received data at 100% of the original size by dividing it into several sheets of paper.
Off	Print the received data by reducing the original size according to the paper size.

For more information about configuring settings, refer to the following:

➔ [Reduced RX Size \(page 8-12\)](#)

## Reception Date/Time

Reception Date/Time function adds the reception date/time, sender information and number of pages on the top of each page when the received fax is printed out. It is useful for confirming the time of reception if the fax is from a different time zone.



### NOTE

When the received fax data is forwarded after retrieving it from memory, the reception date/time is not added to the forwarded data.

When the received data is printed on divided pages, the reception date/time is printed on the first page only. It is not printed on the pages that follow.

On	Print the reception date/time.
Off	Do not print the reception date/time.

For more information about configuring settings, refer to the following:

➔ [Reception Date/Time \(page 8-12\)](#)

## Duplex Printing

When received multiple pages of data are the same width, they can be printed out on both sides of paper having the same width as the data.

On	Print on both sides.
Off	Do not print on both sides.

For more information about configuring settings, refer to the following:

➔ [Duplex Printing \(page 8-12\)](#)

## 2 in 1 Print

When you receive a multi-page Statement or A5 size original, this function prints 2 pages of the original at a time on one Letter or A4 size sheet of paper. If you specify 2 in 1 reception and duplex printing at the same time, 2 in 1 reception is disabled.

On	Print 2 in 1.
Off	Do not print 2 in 1.

For more information about configuring settings, refer to the following:

➔ [2 in 1 Printing \(page 8-12\)](#)

# 5 Using Convenient Fax Functions

This chapter explains the following topics:

Memory Forwarding .....	5-2	Polling Communication .....	5-28
Type of Forwarding Destination and Requirements for Forwarding .....	5-2	Polling Transmission .....	5-28
Forward Settings .....	5-4	Polling Reception .....	5-31
Forward all received documents (Use Rule for All Receptions) .....	5-4	Printing from a Polling Box .....	5-33
Forward only received documents that match the conditions (Use Rule for Specific RX) .....	5-6	Checking Details .....	5-34
Forward received documents that do not match the conditions .....	5-9	Deleting Originals in a Polling Box ....	5-34
Cancelling Memory Forwarding .....	5-9	FAX Memory RX Box .....	5-35
Changing/Deleting Requirements for Forwarding .....	5-10	How to print from the FAX Memory RX Box .....	5-35
Raising the Priority of Requirements for Forwarding .....	5-10	How to delete a fax from the FAX Memory RX Box .....	5-36
Cancelling the Setting of RX/Forward Rules .....	5-10	The fax will be deleted. ....	5-36
Forwarding Detail Settings .....	5-11	Registering an Encryption Key .....	5-38
Forwarding Time Setting .....	5-11	Changing Registration Contents of Encryption Key .....	5-38
File Format Setting .....	5-11	Deleting Registration Contents of Encryption Key .....	5-39
File Separation .....	5-12	Using the Encrypted Transmission ...	5-39
E-mail Subject Add. Info. Setting .....	5-12	Setting the Encrypted Reception .....	5-40
FTP Encrypted TX Setting .....	5-13	Using a Connected Telephone .....	5-41
Print Setting .....	5-14	FAX/TEL Auto Switch Reception .....	5-41
File Name Registration .....	5-15	FAX/Answering Machine Auto Switch Reception .....	5-43
Settings for Forwarding from Command Center RX (Forward Settings) .....	5-16	DRD Reception (Available for some countries.) .....	5-45
FAX Box Function .....	5-17	Manual Send .....	5-47
FAX Box .....	5-17	Manual Reception .....	5-48
Sub Address Communication .....	5-17	Remote Switch Function .....	5-49
Registering a FAX Box .....	5-18		
Changing FAX Box .....	5-20		
Deleting FAX Box .....	5-20		
Printing Originals from a FAX Box .....	5-21		
Checking Details .....	5-22		
Previewing Images .....	5-22		
Deleting Originals after Printing from a FAX Box .....	5-23		
Deleting Originals from a FAX Box .....	5-23		
Printing a FAX Box List .....	5-24		
Sub Address Transmission .....	5-25		
Sub Address Reception .....	5-26		

# Memory Forwarding

When you have received a fax or i-FAX, you can forward the received image to other faxes, computers, and FAX Boxes or specify a number of copies.

## Type of Forwarding Destination and Requirements for Forwarding

You can set forwarding destinations and requirements for forwarding.

### Type of Forwarding Destination

You can forward the received fax to other fax machines or FAX Boxes, send it as an i-FAX or E-mail attachment or transfer it to a folder (SMB or FTP).

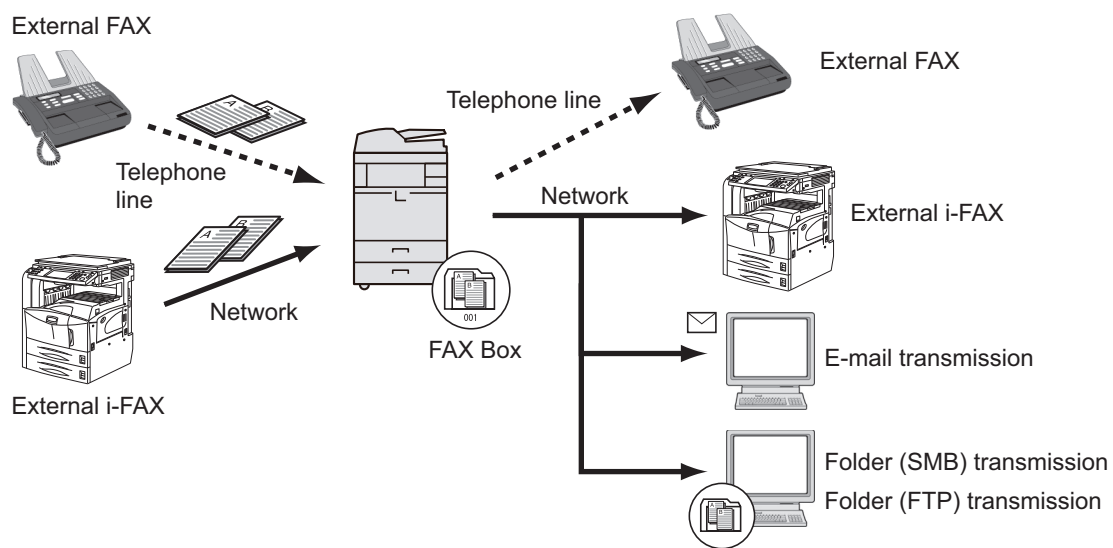

### Requirements for Forwarding

#### ✔ IMPORTANT

A fax or i-FAX that meets one of the specified forwarding requirements will be forwarded to one destination. If the fax meets multiple forwarding requirements, forwarding takes place based on the order of priority of the requirements.

The forwarding requirements are shown in 1 to 4 below. To change the order of priority of the forwarding requirements, refer to the following:

➔ [Raising the Priority of Requirements for Forwarding \(page 5-10\)](#)

The forwarding requirements are as follows:

- 1 Sub address
- 2 Sender fax number
- 3 Port (when 2 optional FAX Kits (Dual FAX option) are installed)
- 4 Recipient's address (i-FAX)

By using the memory forwarding function, you can perform the following communication.

## Sub address confidential delivery

You can store the received originals in the FAX Box registered in advance without printing them, and output the originals without anyone seeing them.

➔ [Sub address confidential delivery \(page 5-26\)](#)

## Sub address relay broadcast communication

Received originals are forwarded to multiple fax machines. By setting a sub address as the forwarding requirement, you can restrict relay broadcasting to a specific communication.

 **NOTE**  
When forwarding is used, you can select whether to print or not to print the received originals. Also, you can specify a number of copies when printing.

➔ [Print Setting \(page 5-14\)](#)

➔ [Sub address relay broadcast communication \(page 5-27\)](#)

# Forward Settings

You can select whether all received documents are forwarded, or only documents that meet the conditions. The table below lists the items to be set.

Function	Description	Reference Page
Off	Do not perform condition-based reception/forwarding. Received faxes are printed on paper.	-
Use Rule for Specific RX	Forward without specifying conditions. Received faxes are all handled in the same way.	<a href="#">5-4</a>
Use Rule for All RX	Forward based on set conditions.	<a href="#">5-6</a>

## Forward all received documents (Use Rule for All Receptions)

By applying the requirements to all receptions, you can have all faxes that you receive be printed or forwarded based on the requirements.

To use requirements for all receptions, use the following procedure.

### NOTE

To register setting by each reception requirement, refer to the following:

▶ [Forward only received documents that match the conditions \(Use Rule for Specific RX\) \(page 5-6\)](#)

To change the entry contents, follow the same operation.

### 1 Display the screen.

[System Menu/Counter] key > [FAX] > "RX/Forward Rules" [Next] > [Use Rule for All RX]

### 2 Configure the Forwarding Destination.

1 "Forward Setting" [Next] > "Forwarding" [Change]

2 [On] or [Off] > [OK]

3 Select "Forward Destination" [Change].

4 Select the other party by selecting one of the following keys > [OK] > [OK]

### NOTE

You can register multiple destinations. By setting a group as the destination, you can specify up to 500 recipients.

Key	Description
Address Book	Select the destination registered in the Address Book or Ext Address Book
E-mail Addr Entry	Forward originals in e-mail transmission. Enter the e-mail address of the other party to which you will forward the received originals.

Key	Description
Folder Path Entry	Forward originals with folder (SMB) transmission or folder (FTP) transmission. Enter the Host Name, Path, Login User Name, and Login Password of the other party to which you will forward the received originals.
FAX No. Entry	Forward originals to another fax. Enter the recipient's fax number using the numeric keys and set the transmission details.
i-FAX Addr Entry	Forward originals using i-FAX. Enter the Internet FAX address of the recipient and set the conditions for the destination machine.

**NOTE**

To edit a registered destination, select the destination to be edited from the list, select **[Detail/Edit]** and edit the information.

To remove a registered destination, select the destination to be removed from the list and select **[Delete]**.

### 3 Configure the Forwarding Detail Settings.

1 You can change the following settings as necessary, and then select **[OK]**.

- File format setting
- E-mail Subject Add. Info setting
- FTP Encrypted TX setting
- File Separation

➔ [Forwarding Detail Settings \(page 5-11\)](#)

2 Select "Storing in FAX Box" **[Change]**.

3 To store the originals in the FAX Box, select **[On]**. If you do not want to store the originals in the FAX Box, select **[Off]**, select **[OK]** and proceed to step 3-5.

**NOTE**

To set the FAX Box as the Forward Destination, register the FAX Box in advance.

➔ [FAX Box Function \(page 5-17\)](#)

4 Select the FAX Box to be used to store the originals and select **[OK]**.  
If you set the password to FAX Box, enter the password and select **[OK]**.

5 You can change the following settings, and then select **[OK]**.

- Number of Copies
- Enable time setting
- File name registration

➔ [Forwarding Detail Settings \(page 5-11\)](#)



## Forward only received documents that match the conditions (Use Rule for Specific RX)

To register settings by each reception requirement, follow the steps below.

Up to 100 requirements can be registered.

### 1 Display the screen.

[System Menu/Counter] key > [FAX] > "RX/Forward Rules" [Next] > [Use Rule for Specific RX]

### 2 Configure the Requirements for Forwarding.

- 1 [Add] > "Rule Number" [Change]
- 2 Select [+] or [-] or use the numeric keys to enter the requirement number (001 to 100) > [OK]
- 3 Select "Rule Name" [Change].
- 4 Enter the requirement name > [OK]



#### NOTE

Up to 32 characters can be entered for the requirement name.

For details on character entry, refer to the following:

➔ [Character Entry Method \(page 12-2\)](#)

- 5 Select "Rule" [Change].
- 6 To forward fax reception, select [FAX] or [i-FAX] > [Next].
- 7 Register the requirements > [OK]

#### When FAX was selected in step 6.

Requirements	Registration method
Sub Address	Select [ <b>Sub Address</b> ] and enter the sub address using the numeric keys. You can use up to 20 digits including the numbers from 0 to 9, ' (space)', '#' and '*' characters to enter a sub address.
Sender FAX Number	Select [ <b>Sender FAX Number</b> ] and enter the sender's fax number using the numeric keys. You can enter up to 20 characters.
Port	Select [ <b>Port</b> ] and select [ <b>Port 1</b> ] or [ <b>Port 2</b> ]. If the port is selected, fax box forwarding will not be possible. This setting only appears when 2 optional FAX Kits (Dual FAX option) are installed.

#### When i-FAX was selected in step 6.

Requirements	Registration method
i-FAX Address	Select [ <b>i-FAX Address</b> ]. Enter the destination Internet FAX address. You can enter up to 256 characters.

 **NOTE**

When setting a forwarding condition by selecting a sender's FAX number (a local FAX information entry of the destination machine) but leaving blank to the sender's FAX number, you can forward a FAX that is received from a sender whose number is not registered in the sender's FAX number entries.

When you set the sender fax number as a forwarding requirement, select the search requirement from Search by pull-down menu.

- Same as
- Starts with
- Ends with
- Includes

**3 Configure the Forwarding Destination.**

- 1 "Forward Setting" [**Next**] > "Forwarding" [**Change**]
- 2 [**On**] or [**Off**] > [**OK**]
- 3 Select "Forward Destination" [**Change**].
- 4 Select the other party by selecting one of the following keys > [**OK**] > [**OK**]

Key	Description
Address Book	Select the destination registered in the Address Book or Ext Address Book
E-mail Addr Entry	Forward originals in e-mail transmission. Enter the e-mail address of the other party to which you will forward the received originals.
Folder Path Entry	Forward originals with folder (SMB) transmission or folder (FTP) transmission. Enter the Host Name, Path, Login User Name, and Login Password of the other party to which you will forward the received originals.
FAX No. Entry	Forward originals to another fax. Enter the recipient's fax number using the numeric keys and set the transmission details.
i-FAX Addr Entry	Forward originals using i-FAX. Enter the Internet FAX address of the recipient and set the conditions for the destination machine.

 **NOTE**

To edit a registered destination, select the destination to be edited from the list, select [**Detail/Edit**] and edit the information.

To remove a registered destination, select the destination to be removed from the list and select [**Delete**].

**4 Configure the Forwarding Detail Settings.**

- 1 You can change the following settings as necessary, and then select [**OK**].
  - File format

- E-mail Subject Add. Info
- FTP Encrypted TX
- File Separation

➔ [Forwarding Detail Settings \(page 5-11\)](#)

- 2 Select "Storing in FAX Box" [**Change**].



**NOTE**

If the forwarding conditions are as follows, Save to FAX Box cannot be configured.

- If "Port" is configured.
- Save to FAX Box cannot be configured for "Others" of a forwarding condition.

- 3 To store the originals in the FAX Box, select [**On**]. If you do not want to store the originals in the FAX Box, select [**Off**], select [**OK**] and proceed to step 4-5.



**NOTE**

To set the FAX Box as the Forward Destination, register the FAX Box in advance.

➔ [FAX Box Function \(page 5-17\)](#)

- 4 Select the FAX Box to be used to store the originals and select [**OK**].  
If you set the password to FAX Box, enter the password and select [**OK**].

- 5 You can change the following settings, and then select [**Register**].

- Number of Copies
- Enable time setting
- File name registration

➔ [Forwarding Detail Settings \(page 5-11\)](#)

To register another forwarding settings, repeat steps 2-1 to 4-5.

- 6 Select the checkbox beside the forwarding settings to be enabled from the list.  
The checkbox beside the forwarding setting to be enabled is checked.



**NOTE**

To disable the setting, select the checkbox to delete the checkmark.

- 7 Select [**OK**].  
The setting is saved by each requirement.

## Forward received documents that do not match the conditions

To forward received documents that do not match the conditions, follow the procedure below.

### 1 Follow steps 1 to 4-5 of Forward only received documents that match the conditions (Use Rule for Specific RX).

- ➔ [Forward only received documents that match the conditions \(Use Rule for Specific RX\) \(page 5-6\)](#)

### 2 Change the Forwarding Settings.

- 1 [others] > [Detail]
- 2 Change the Forwarding Settings > [Save]



#### NOTE

If [others] is not selected, received faxes that do not meet the conditions will be printed.  
Save to FAX Box cannot be set in [others] settings.

### 3 Register the Forwarding Settings.

- 1 Select the checkbox beside the forwarding settings to be enabled from the list.  
The checkbox beside the forwarding setting to be enabled is checked.



#### NOTE

To disable the setting, select the checkbox to delete the checkmark.

- 2 Select [OK].

## Cancelling Memory Forwarding

To cancel memory forwarding, break the connection and then cancel forwarding.

- ➔ [Cancelling Transmission \(Disconnection of Communication\) \(page 3-6\)](#)

## Changing/Deleting Requirements for Forwarding

To change or delete the requirements for forwarding, follow the steps below.

### 1 Display the screen.

Follow steps 1 of "Use Rule for Specific RX" on page 4-21.

➔ [Forward only received documents that match the conditions \(Use Rule for Specific RX\)](#)

### 2 Configure the function.

- 1 Select the requirement name to be deleted or changed.  
To delete the requirement name, go to the next step. To change the requirement name, go to step 3.
- 2 Select **[Delete]**.  
When the confirmation screen is displayed, select **[Yes]** and go to step 5.
- 3 Select **[Detail]**.
- 4 Refer to steps 2 to 4 of "Use Rule for Specific RX" to change the settings.  
➔ [Forward only received documents that match the conditions \(Use Rule for Specific RX\)](#)
- 5 When the deletion or change is completed, Select **[OK]**.

## Raising the Priority of Requirements for Forwarding

To raise the priority of the requirements for forwarding, follow the steps below.

### 1 Display the screen.

Follow steps 1 of "Use Rule for Specific RX" on page 4-21.

➔ [Forward only received documents that match the conditions \(Use Rule for Specific RX\)](#)

### 2 Configure the function.

- 1 Select the requirement name to be reprioritized.
- 2 Select **[Raise Priority]**.  
The priority of the selected requirement is raised.

## Cancelling the Setting of RX/Forward Rules

To cancel the memory forwarding, follow the steps below.

### 1 Display the screen.

[System Menu/Counter] key > **[FAX]** > "RX/Forward Rules" **[Next]**

### 2 Configure the function.

**[Off]** > **[OK]**

# Forwarding Detail Settings

## Forwarding Time Setting

Register the start time and end time between which forwarding is enabled.

### 1 Display the screen.

#### Use Rule for All Receptions

- 1 Follow steps 1 of Forward all received documents (Use Rule for All Receptions).

➔ [Forward all received documents \(Use Rule for All Receptions\) \(page 5-4\)](#)

- 2 Select "Schedule" [**Change**].

#### Use Rule for Specific RX

- 1 Follow steps 1 of Forward only received documents that match the conditions (Use Rule for Specific RX), select the rule, and select [**Detail**].

➔ [Forward only received documents that match the conditions \(Use Rule for Specific RX\) \(page 5-6\)](#)

- 2 Select "Schedule" [**Change**].

### 2 Configure the function.

- 1 Select [**All Day**] or [**Preset Time**]. If Preset Time is selected, enter the [**Start Time**] and [**End Time**].



#### NOTE

Enter the time on the 24 hours system.

- 2 Select [**OK**].

## File Format Setting

If you are sending the file as an E-mail attachment or transferring it to a folder (SMB or FTP), select PDF, TIFF, XPS, or OpenXPS as the file format.

### 1 Display the screen.

#### Use Rule for All Receptions

- 1 Follow steps 1 of Forward all received documents (Use Rule for All Receptions), and select [**Next**] of "Forward Setting".

➔ [Forward all received documents \(Use Rule for All Receptions\) \(page 5-4\)](#)

- 2 Select "File Format" [**Change**].

#### Use Rule for Specific RX

- 1 Follow steps 1 of Forward only received documents that match the conditions (Use Rule for Specific RX), select the rule, and select [**Detail**].

➔ [Forward only received documents that match the conditions \(Use Rule for Specific RX\) \(page 5-6\)](#)

- 2 "Forward Setting" [**Next**] > "File Format" [**Change**]

## 2 Configure the function.

[**PDF**], [**TIFF**], [**XPS**] or [**OpenXPS**] > [**OK**]



### NOTE

If you have selected [**PDF**] for file format, PDF/A settings and PDF Encryption functions are available. Additionally, if you have started up the optional OCR Scan Activation Kit, OCR Text Recognition and Auto Image Rotation settings are available.

➔ *Machine's Operation Guide*

## File Separation

When sending by e-mail transmission, folder (SMB) transmission, or folder (FTP) transmission, specify whether File Separation is performed.

### 1 Display the screen.

#### Use Rule for All Receptions

- 1 Follow steps 1 of Forward all received documents (Use Rule for All Receptions), and select "Forward Setting" [**Next**].

➔ [Forward all received documents \(Use Rule for All Receptions\) \(page 5-4\)](#)

- 2 Select "File Separation" [**Change**].

#### Use Rule for Specific RX

- 1 Follow steps 1 of Forward only received documents that match the conditions (Use Rule for Specific RX), select the rule, and select [**Detail**].

➔ [Forward only received documents that match the conditions \(Use Rule for Specific RX\) \(page 5-6\)](#)

- 2 "Forward Setting" [**Next**] > "File Separation" [**Change**]

### 2 Configure the function.

[**Each Page**] or [**Off**] > [**OK**]

To create one file per page, select [**Each Page**].

## E-mail Subject Add. Info. Setting

Specify whether any information will be added to the subject of the E-mail. When adding information, you can select either Sender Name or Sender.

### 1 Display the screen.

#### Use Rule for All Receptions

- 1 Follow steps 1 of Forward all received documents (Use Rule for All Receptions), and select "Forward Setting" [**Next**].

➔ [Forward all received documents \(Use Rule for All Receptions\) \(page 5-4\)](#)

- 2 Select "E-mail Subject Add. Info" [**Change**].

### Use Rule for Specific RX

- 1 Follow steps 1 of Forward only received documents that match the conditions (Use Rule for Specific RX), select the rule, and select **[Detail]**.
  - ➔ [Forward only received documents that match the conditions \(Use Rule for Specific RX\) \(page 5-6\)](#)
- 2 "Forward Setting" **[Next]** > "E-mail Subject Add. Info" **[Change]**

## 2 Configure the function.

Select **[Sender Name]**, **[Sender FAX No./Address]**, or **[Off]** > **[OK]**

## FTP Encrypted TX Setting

Specify whether to use FTP encryption when you send data.



### NOTE

To use FTP encryption, set "SSL" to **[On]** in the Secure Protocol settings.

➔ [Machine's Operation Guide](#)

## 1 Display the screen.

### Use Rule for All Receptions

- 1 Follow steps 1 of Forward all received documents (Use Rule for All Receptions), and select "Forward Setting" **[Next]**.
  - ➔ [Forward all received documents \(Use Rule for All Receptions\) \(page 5-4\)](#)
- 2 Select "FTP Encrypted TX" **[Change]**.

### Use Rule for Specific RX

- 1 Follow steps 1 of Forward only received documents that match the conditions (Use Rule for Specific RX), select the rule, and select **[Detail]**.
  - ➔ [Forward only received documents that match the conditions \(Use Rule for Specific RX\) \(page 5-6\)](#)
- 2 "Forward Setting" **[Next]** > "FTP Encrypted TX" **[Change]**

## 2 Configure the function.

Select **[On]** or **[Off]** > **[OK]**



## Print Setting

You can set whether the machine should print received originals when forwarding them.

### 1 Display the screen.

#### Use Rule for All Receptions

- 1 Follow steps 1 of Forward all received documents (Use Rule for All Receptions).  
➔ [Forward all received documents \(Use Rule for All Receptions\) \(page 5-4\)](#)

- 2 Select "Print" [**Change**].

#### Use Rule for Specific RX

- 1 Follow steps 1 of Forward only received documents that match the conditions (Use Rule for Specific RX), select the rule, and select [**Detail**].  
➔ [Forward only received documents that match the conditions \(Use Rule for Specific RX\) \(page 5-6\)](#)

- 2 Select "Print" [**Change**].

### 2 Configure the function.

[**On**] or [**Off**] > [**OK**]

If you selected [**On**], select [+]/[-] or numeric keys to set the number of copies.

## File Name Registration

You can set the file name to be created when forwarding. You can append information such as the date/time and the job number or fax number (address for an i-FAX).

### 1 Display the screen.

#### Use Rule for All Receptions

- 1 Follow steps 1 of Forward all received documents (Use Rule for All Receptions).

➔ [Forward all received documents \(Use Rule for All Receptions\) \(page 5-4\)](#)

- 2 Select "File Name" [**Change**].

#### Use Rule for Specific RX

- 1 Follow steps 1 of Forward only received documents that match the conditions (Use Rule for Specific RX), select the rule, and select [**Detail**].

➔ [Forward only received documents that match the conditions \(Use Rule for Specific RX\) \(page 5-6\)](#)

- 2 Select "File Name" [**Change**].

### 2 Configure the function.

- 1 [**File Name**] > Enter the file name > [**Save**]



#### NOTE

For details on character entry, refer to the following:

➔ [Character Entry Method \(page 12-2\)](#)

- 2 To insert additional information into the file name, select [**Job No.**], [**Date and Time**], [**Add No./Addr to Front**] or [**Add No./Addr to Back**].



#### NOTE

Please note that when you have not add any additional information, file names become the same, and, therefore, old files are overwritten when received originals are forwarded with folder (SMB) transmission and folder (FTP) transmission.

File name sample

**Example:** doc00352720140826181723.pdf

doc (file name) + 6-digit job number + year/month/day/hour/minute/second +file format (default setting is .pdf)

## Settings for Forwarding from Command Center RX (Forward Settings)

You can use Command Center RX on a computer connected to the network to specify the forwarding settings on this machine.

For information on the network settings, refer to the followings:

➔ *Machine's Operation Guide*

### Accessing Command Center RX

#### 1 Display Command Center RX.

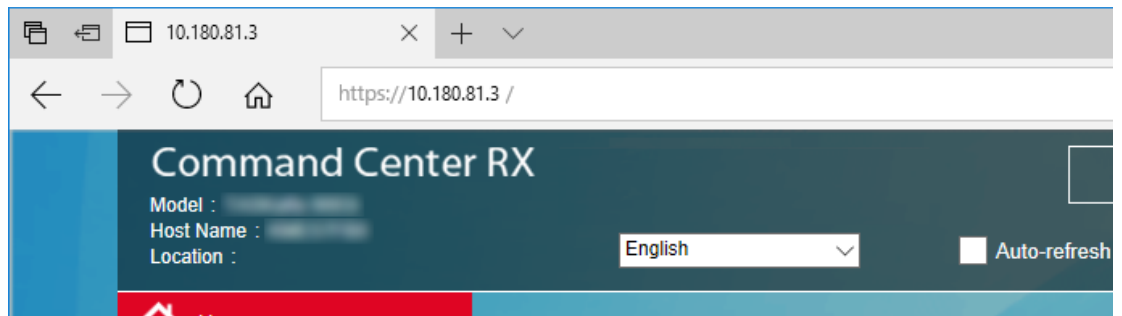

1 Open the web browser.

2 In the Address or Location bar, enter the machine's IP address as the URL, e.g. 10.180.81.3/.

The web page displays basic information about the machine and Command Center RX as well as the current status of the machine.

#### 2 Select settings in Command Center RX.

Select a category from the navigation bar on the left to view and set values for that particular category.

If administrator privileges have been enabled on Command Center RX, remember to enter the correct user name and password when trying to access the relevant screens.

➔ *Command Center RX User Guide*

# FAX Box Function

## FAX Box

A FAX Box is a box for storing received originals on the machine to which the FAX System is to be installed. Using the memory forwarding function, you can store received originals in a personal FAX Box.



### NOTE

If saving the received fax data in the FAX Memory RX Box, refer to the following.

- ▶ [FAX Memory RX Box \(page 5-35\)](#)

For the method for using a FAX Box, see the next section.

- Registering a FAX Box ▶ page 5-18
- Changing FAX Box ▶ page 5-20
- Deleting FAX Box ▶ page 5-20

For the method for manipulating a received fax stored in a FAX Box, see the next section.

- Printing Originals from a FAX Box ▶ page 5-21
- Checking Details ▶ page 5-22
- Deleting Originals after Printing from a FAX Box ▶ page 5-23
- Deleting Originals from a FAX Box ▶ page 5-23
- Printing a FAX Box List ▶ page 5-24

For the method for transmitting to a FAX Box, see the next section.

- Sub Address Transmission ▶ page 5-25

For the method for receiving to a FAX Box, see the next section.

- Sub Address Reception ▶ page 5-26

## Sub Address Communication

Sub address communication is communication in which data is sent and received with sub addresses and passwords attached in conformance with the ITU-T (International Telecommunication Union) recommendations. Sub addresses enable communication modes with third-party machines that were previously only possible between our brand machines. These include confidential delivery (sending originals to an original delivery box set up in the receiving system) and polling communication (reception of documents from a source machine that is controlled from the receiving machine). Using sub address communication and the memory forwarding function on this machine also allows advanced communication functions such as storing received originals in FAX Boxes and forwarding originals to other fax machines.



### NOTE

In order to conduct sub address communication, the other party's system also needs to be equipped with sub address communication functions of the same type.

Sub address-based communication can be used together with various kind of functional communication.

When registering a sub address and sub address password in the Address Book and One Touch Key, you can omit their entry before transmission. For details, refer to the explanations in the procedure of each communication method and registration method.

## Sub Address

With the machine, sub address and sub address passwords are called sub address.

**Sub Address**

Use the numbers from 0 to 9, ' (space)', and '#' and '\*' characters to enter a sub address of up to 20 digits. When the machine receives originals, the sub address is used as the forward requirement for memory forwarding.

**Sub Address Password**

Use the numbers from 0 to 9, alphabets, ' (space)', and '#' and '\*' characters to enter a sub address password of up to 20 digits. When the machine receives originals, a sub address password is not used.

For the procedure for setting a sub address, refer to the following:

- ➔ [Sub Address Transmission \(page 5-25\)](#)
- [Sub Address Reception \(page 5-26\)](#)

## Registering a FAX Box

Up to 100 FAX Boxes can be registered.

**NOTE**

If user login administration is enabled, you can only edit destinations in the Address Book by logging in with administrator privileges.

FAX Boxes can also be registered in the system menu.

### 1 Display the screen.

[FAX Box] on the Home screen > [Add/Edit Box]

### 2 Configure the function.

- 1 Select [Add].
- 2 Enter the information and then select [OK].

The table below lists the items to be set.

Item	Description
Box No.	Enter the box number by selecting [+], [-] or number keys. The box number can be from 0001 to 1000. A Custom Box should have a unique number. If you enter 0000, the smallest number available will be automatically assigned.
Owner <sup>*1</sup>	Set the owner of the box. Select the owner from the user list that appears.
Box Name	Enter a box name consisting of up to 32 characters. Refer to the following for details on entering characters. ➔ <a href="#">Character Entry Method (page 12-2)</a>
Box Password	User access to the box can be restricted by specifying a password to protect the box. Entering a password is not mandatory. Enter the same password of up to 16 characters in both [Password] and [Confirm Password].
Permission <sup>*1</sup>	Select whether to share the box.
Delete after Printed	Automatically delete a document from the box once printing is complete. To delete the document, select [On]. To retain the document, select [Off].

\*1 Displayed when the user login administration is enabled.

**3 Check the details you have entered and then select [Save].**

A box is created.

## Changing FAX Box



### NOTE

FAX Boxes can also be changed in the system menu.

### 1 Display the screen.

[FAX Box] on the Home screen > [Add/Edit Box]

### 2 Changing

Select the box that you want to change > [Detail/Edit]

Change the settings.

The table below lists the items to be set.

Item	Description
Box No.	Enter the box number by selecting [+], [-] or number keys. The box number can be from 0001 to 1000. A Custom Box should have a unique number. If you enter 0000, the smallest number available will be automatically assigned.
Owner* <sup>1</sup>	Set the owner of the box. Select the owner from the user list that appears.
Box Name	Enter a box name consisting of up to 32 characters. Refer to the following for details on entering characters. <a href="#">▶ Character Entry Method (page 12-2)</a>
Box Password	User access to the box can be restricted by specifying a password to protect the box. Entering a password is not mandatory. Enter the same password of up to 16 characters in both [Password] and [Confirm Password].
Permission* <sup>1</sup>	Select whether to share the box.
Delete after Printed	Automatically delete a document from the box once printing is complete. To delete the document, select [On]. To retain the document, select [Off].

\*1 Displayed when the user login administration is enabled.

## Deleting FAX Box



### NOTE

FAX Boxes can also be deleted in the system menu.

### 1 Display the screen.

[FAX Box] on the Home screen > [Add/Edit Box]

### 2 Deleting

1 Select the box that you want to delete.

2 [Delete] > [Yes]

The box is deleted.

## Printing Originals from a FAX Box

To print the originals that have been sent to a FAX Box, use the following operation.

### 1 Select [FAX Box] on the Home screen.

### 2 Selecting the Originals.

- 1 Select the box containing the document you want to print > [Open]



#### NOTE

When the password is set to a FAX Box, you need to enter the password in the following situations:

If user login administration is disabled

If user login administration is enabled but the FAX Box has been selected by another user when you login with user privileges

- 2 Select the document you want to print.  
The selected originals are check-marked.



#### NOTE

To cancel the selection, select the checkbox and delete the checkmark.

When [  ] is selected in the fax box screen, a thumbnail of the original image appears.

To check the image of the originals, refer to the preview.

➔ [Previewing Images \(page 5-22\)](#)

For information on working with lists in FAX Boxes, refer to the following:

➔ *Machine's Operation Guide*

From a FAX Box, only printing is available. Sending cannot be done.

- 3 Select [Print].

### 3 Print

- 1 Select whether the originals are to be deleted from the FAX Box after printing is completed.  
To delete the data, select [On].
- 2 Select [Start Print].  
The print starts.



## Checking Details

You can use the procedure below to check the details of documents forwarded to a FAX Box.

- 1** Select [FAX Box] on the Home screen.
- 2** Selecting the Originals.
  - 1** Select the box containing the document you want to check > [Open]
  - 2** Select the document whose details you want to check > [Detail]  
The details of the selected document are displayed.  
Select "File Name" [Change] to rename the file.

➔ [Character Entry Method \(page 12-2\)](#)

## Previewing Images

You can use the procedure below to preview an image of an original forwarded to a FAX Box on the touch panel.

- 1** Select [FAX Box] on the Home screen.
- 2** Selecting the Originals.
  - 1** Select the box containing the document you want to check > [Open]
  - 2** Selecting the Originals > [Preview]  
The preview screen appears

### Using the Preview screen

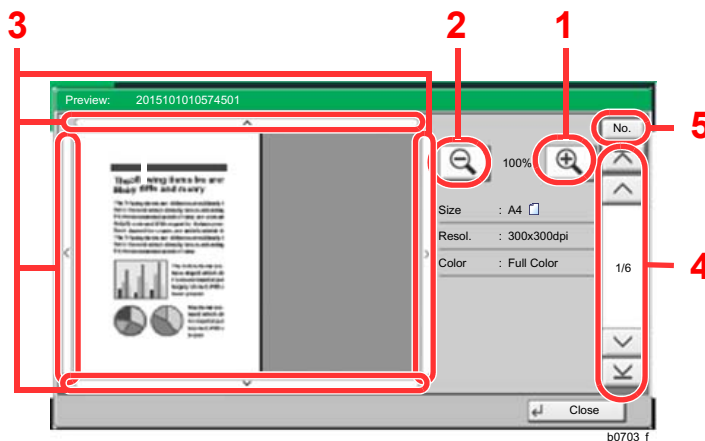

- 1** Zoom in.
- 2** Zoom out.
- 3** When you have zoomed in, you can use these keys to move the displayed area.
- 4** In multiple-page documents, you can use these buttons to change pages.
- 5** In multiple-page documents, you can change pages by entering the desired page number.



#### NOTE

The preview display can be controlled by moving your finger(s) on the touch panel.

➔ [Previewing Images \(page 2-7\)](#)

## Deleting Originals after Printing from a FAX Box

To automatically delete the originals printed from the FAX Box, use the following operation.

- 1 Select [FAX Box] on the Home screen.**
- 2 Selecting the Originals.**
  - 1** Select the box containing the document you want to print > **[Open]**
  - 2** Select the document you want to print.
  - 3** Select **[Print]**.
- 3 Configure the function.**

Select **[On]**.
- 4 Print.**

Select **[Start Print]**.  
The original is deleted after printing.

## Deleting Originals from a FAX Box

Use the procedure below to delete an original that you have forwarded to a FAX Box.

- 1 Select [FAX Box] on the Home screen.**
- 2 Deleting**
  - 1** Select the box containing the document you want to delete > **[Open]**
  - 2** Select the document you want to delete > **[Delete]** > **[Yes]**  
The original is deleted.

## Printing a FAX Box List

You can print the FAX Box list in which the list of Box No.'s and Box names of the registered FAX Boxes are described. When there are originals in the FAX Boxes, the number of pages is displayed.



### NOTE

The list can be printed when user login administration has been enabled and the machine is logged in with administrator privileges.

#### 1 Display the screen.

[System Menu/Counter] key > [Document Box/USB Drive] > "FAX Box" [Next]

#### 2 Print

"FAX Box List" [Print] > [Yes]

The list is printed.

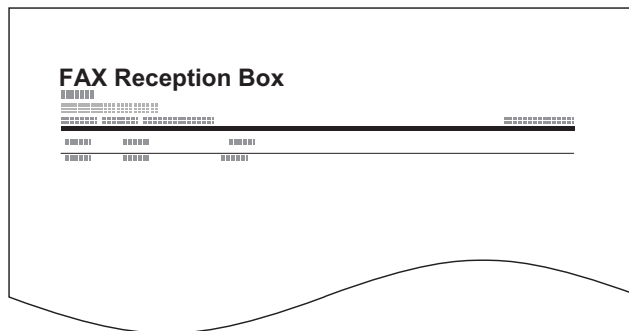

## Sub Address Transmission

To specify a FAX Box when sending a fax, follow the steps below.

### NOTE

To use sub address transmission, check that a sub address and password have been set in the receiving system in advance.

Encrypted transmission cannot be used in sub address transmission.

For the setting method when the machine receives originals, refer to the following:

➔ [FAX Box Function \(page 5-17\)](#)

### 1 Select [FAX] on the Home screen.

### 2 Place the originals.

### 3 Specifying destination.

Use the numeric keys to enter the destination fax number.

### NOTE

When a sub address has been registered to the destination of the Address Book, you can use the destination. When a sub address-registered destination in the Address Book is used for a One Touch Key, you can also use the One Touch Key.

### 4 Configure the function.

1 [Detail] > "Sub Address" [Change] > [Sub Address]

2 Enter the sub address using the numeric keys, and then enter the [OK] key.  
You can use up to 20 digits including the numbers from 0 to 9, ' (space)', '#' and '\*' characters to enter a sub address.

3 Select [Password].

4 Enter the sub address password using the numeric keys, and then enter the [OK] key.  
You can use up to 20 digits including the numbers from 0 to 9, ' (space)', '#' and '\*' characters to enter a sub address password.

### NOTE

When the machine receives originals, a sub address password is not used.

5 [OK] > [OK]

### 5 Send Start.

Check the destination and press the [Start] key.

### NOTE

When [On] is selected in [Dest. Check before Send], a destination confirmation screen is displayed when you press the [Start] key.

➔ [Confirmation Screen of Destinations \(page 7-13\)](#)

## Sub Address Reception

To perform sub-address reception, you must inform the sending party of the machine's sub-address and password prior to transmission.

When sub-address reception is performed, the functions below can be used.

- Memory Forwarding ..... 5-2
- Sub address confidential delivery ..... 5-26
- Sub address relay broadcast communication ..... 5-27
- Sub Address Bulletin Board Reception ..... 5-31

**IMPORTANT**  
 To use sub-address reception functions, settings must be configured. To configure the settings, refer to the following:

- ➔ [Memory Forwarding \(page 5-2\)](#)
- ➔ [Using Polling Reception with Sub Addresses \(page 5-32\)](#)

### Sub address confidential delivery

You can store the received originals in the FAX Box registered in advance without printing them, and output the originals without anyone seeing them.

Setting example

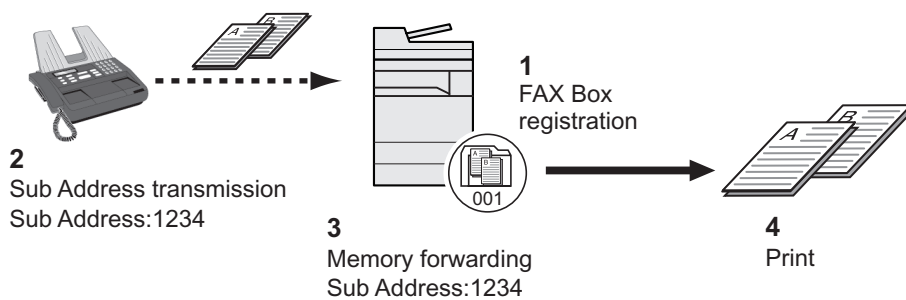

- 1 Register the FAX Box.  
 ➔ [Registering a FAX Box \(page 5-18\)](#)
- 2 Perform sub address transmission.
- 3 Store originals in the FAX Box with memory forwarding.
- 4 Print originals from the FAX Box.  
 ➔ [Printing Originals from a FAX Box \(page 5-21\)](#)

## Sub address relay broadcast communication

Received originals are forwarded to multiple fax machines. By setting a sub address as the forwarding requirement, you can restrict relay broadcasting to a specific communication.

### NOTE

When forwarding is used, you can select whether to print or not to print the received originals. Also, you can specify a number of copies when printing.

➔ [Print Setting \(page 5-14\)](#)

Setting example

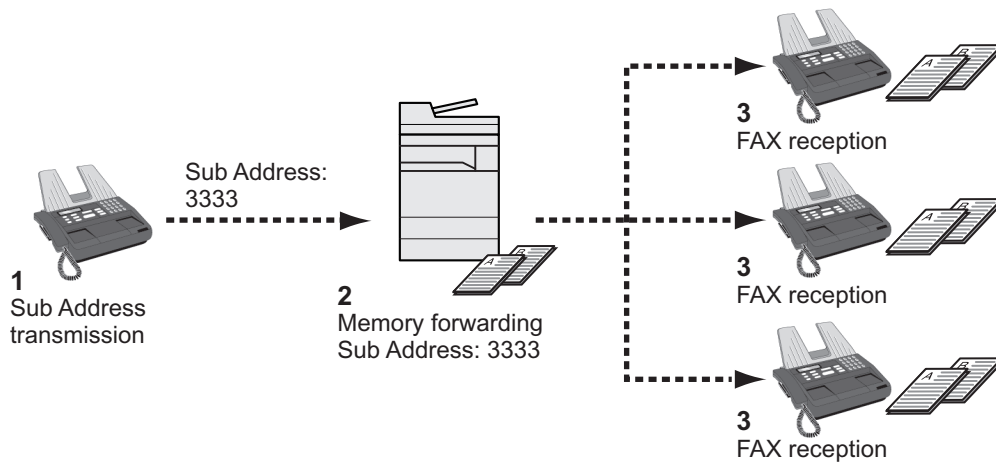

- 1 Perform sub address transmission.
- 2 Use memory forwarding to forward received originals to multiple fax machines.
- 3 Each forwarding destination receives the fax.

# Polling Communication

Polling communication is a communication mode in which the transmission of originals on the sending machine is controlled by the receiving machine. This allows the receiving machine to tailor the reception of originals to its own circumstances. This machine supports both polling transmission and polling reception.



## IMPORTANT

**Because the receiving machine dials the sending machine in polling communication, call charges are normally borne by the recipient.**

## Polling Transmission

Originals to be used in polling transmissions should be stored in a Polling box. When a polling request is received from the destination, the stored originals are sent automatically.

Once originals intended for polling transmission have been sent to the destination, they are automatically deleted. However, if you set Delete Transmitted File to **[Off]**, the originals are stored in the Polling box until you delete them. You can use polling transmission with the same originals as many times as you wish.

➔ [Deleting Originals After Polling Transmission \(page 5-28\)](#)



## NOTE

You can store up to 10 documents for polling transmission when a sub-address is not used. When a sub-address is used, up to 10 documents can be stored per sub-address.

You can also add to or overwrite originals up until a polling request arrives from the destination.

➔ [Overwrite Setting \(page 5-28\)](#)

## Deleting Originals After Polling Transmission

Originals intended for polling transmission are automatically deleted after they have been sent to the destination. To allow polling transmission of the same original to multiple destinations, set this option to **[Off]**.

### 1 Display the screen.

[System Menu/Counter] key > **[Document Box/USB Drive]** > "Polling Box" **[Change]**

### 2 Configure the function.

"Delete Transmitted File" **[Change]** > **[On]** or **[Off]** > **[OK]**

## Overwrite Setting

To allow overwriting, set this option to **[Permit]**.

Use the procedure below to overwrite the existing document if the same name is added to the new file.

If this option is set to **[Prohibit]**, the existing document will not be overwritten if the same file name is set.

### 1 Display the screen.

[System Menu/Counter] key > **[Document Box/USB Drive]** > "Polling Box" **[Change]**

### 2 Configure the function.

"Overwrite Setting" **[Change]** > **[Permit]** or **[Prohibit]** > **[OK]**

## Using Polling Transmission

### 1 [FAX Box] on the Home screen > [Polling Box]

### 2 Place the originals.

### 3 Display the screen.

Select [Store File].

### 4 Select the type of originals, scanning density, etc., as necessary.

The table below lists the items to be set.

Function	Description
Original Image	Select image quality.
Mixed Sized Originals* <sup>1</sup>	Allows you to use the document processor to load and store multiple originals of different sizes.
2-sided/Book Original* <sup>2</sup>	Select the type and binding of originals.
Original Orientation	To ensure that the originals are stored in the correct orientation, this indicates the orientation of the original document top edge. To use the following functions, select the orientation of the originals. <ul style="list-style-type: none"> <li>• 1-sided / 2-sided Selection</li> <li>• Border Erase/Full Scan</li> </ul>
Storing Size	Selects the storage size (the size of stored originals).
Density	Adjusts the density used for scanning originals.
Original Image	Select the image quality according to the original image type.
Scan Resolution	Chooses the level of detail used for scanning originals.
Zoom	Automatically enlarges or reduces scanned originals to match the storage size.
Centering	When you have scanned the original after specifying the original size and sending size, depending on these sizes, a margin is created at the bottom, left, or right side of paper. By using the centering, the image is placed with a margin equally created at each of the page Top/Bottom and Left/Right.
Border Erase/Full Scan	Scans originals with the black frame around the outside of the originals erased.
Continuous Scan	Allows you to divide originals that cannot be placed in the document processor at one time into multiple scans and then store the result as a single file. With this function, originals continue to be scanned until you select [Finish Scan].
Job Finish Notice	Sends a notice by an e-mail when a scanning is complete.



Function	Description
File Name Entry	Allows you to rename the files created from scanned originals. You can also use this function to add the job number and/or date.
Erase Shadowed Areas	When scanning with the document processor open, erase the extra shaded area.
Skip Blank Page	When there are blank pages in a scanned document, this function skips the blank pages and scans only pages that are not blank.
Long Original <sup>*1</sup>	Allows you to use the document processor to scan overlength originals (documents that are long in the feed direction).
Sub Address	Set a Sub-Address for the document.

\*1 This is displayed if the document processor is optional, and has been installed.

\*2 The display reads "Book original" if the document processor is optional, and has not been installed.

For each of the functions, refer to the following:

➔ [Sending Faxes \(page 3-1\)](#)  
Machine's Operation Guide

## 5 Start storing.

Press the [**Start**] key. The originals are scanned and stored in the Polling box.



### NOTE

You can see a preview of the image to be stored by selecting [**Preview**].

➔ [Previewing Images \(page 2-7\)](#)

## Cancelling Polling Transmissions

To cancel a polling transmission, delete the polling transmission original saved in the polling box. For information on how to delete the saved original, refer to the following:

➔ [Deleting Originals in a Polling Box \(page 5-34\)](#)

## Polling Reception

This function automatically triggers transmission of originals stored on the sending machine when the receiving machine dials the sending machine's number.

### NOTE

By setting a group as the destination, you can receive originals from up to 500 contacts in a single operation. If you specified a destination for which encrypted communication is registered, encrypted communication is disabled for polling reception.

When 2 optional FAX Kits (Dual FAX option) are installed and a receive-only port is specified, communication is via the other port.

To use polling reception, you must first ensure that the sending machine is set up for polling transmission.

Using sub addresses at the same time allows the communication modes described below.

### Sub Address Bulletin Board Reception

If the recipient's machine has a sub address bulletin board function, you can use sub addresses to communicate with that machine even if it is a third-party machine. (On this machine, the sub address and sub address password.)

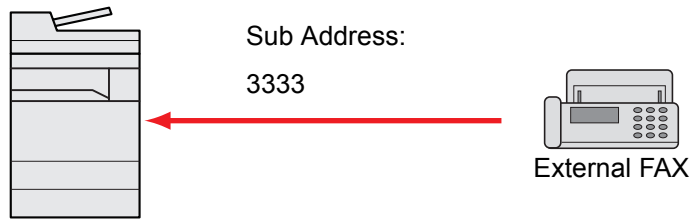

### IMPORTANT

**The recipient's machine must also be equipped with a sub address bulletin board function. Some fax machines cannot store originals and some do not support polling transmission. Check both the sending and receiving machines beforehand to ensure that they each have the required functionality.**

**Ask the recipient for the sub address and password that are registered in the recipient's machine.**

### NOTE

For more information on sub addresses, refer to the following:

➔ [Sub Address Communication \(page 5-17\)](#)

For information on how to receive files using sub address bulletin board communication, refer to the following:

➔ [Using Polling Reception with Sub Addresses \(page 5-32\)](#)

## Using Polling Reception



### NOTE

When the other party is using sub addresses, refer to Using Polling Reception with Sub Addresses below.

**1** Select **[FAX]** on the Home screen.

**2** Turn on polling reception.

[Advanced Setup] > [FAX Polling RX] > [On] > [OK]

**3** Specifying destination.

➔ [Methods For Entering the Destination \(page 3-7\)](#)

**4** Press the **[Start]** key.

The operations for reception begin.



### NOTE

When [On] is selected in [Dest. Check before Send], a destination confirmation screen is displayed when you press the [Start] key.

➔ [Confirmation Screen of Destinations \(page 7-13\)](#)

## Using Polling Reception with Sub Addresses

For polling reception, enter the sub address (on this machine, sub address and sub address password) set at the sending machine. This communication is still possible when the other party is using a third-party machine provided it is equipped with the same type of sub address communication function.



### IMPORTANT

Check the sub address set by the sender beforehand.

**1** Select **[FAX]** on the Home screen.

**2** Turn on polling reception.

To turn on polling reception, refer to the following:

➔ [Polling Reception \(page 5-31\)](#)

**3** Select the destination, and entering the sub address.

For the procedure for setting a sub address, refer to the following:

➔ [Sub Address Transmission \(page 5-25\)](#)

For the procedure for selecting a destination, refer to the following:

➔ [Methods For Entering the Destination \(page 3-7\)](#)



### NOTE

You can select destinations using a combination of numeric keys input, One Touch Key selection and selection from the Address Book containing registered sub addresses.

## 4 Press the [Start] key.

The operations for reception begin.



### NOTE

When [On] is selected in [Dest. Check before Send], a destination confirmation screen is displayed when you press the [Start] key.

➔ [Confirmation Screen of Destinations \(page 7-13\)](#)

## Printing from a Polling Box

Use this procedure to print an original stored in a Polling box.

### 1 [FAX Box] on the Home screen > [Polling Box]

### 2 Select the original.

Select the document you want to print.

The selected originals are check-marked.



### NOTE

To cancel a selection, select the checkbox again so that it is no longer ticked.

To check the image of the originals, refer to the preview.

➔ [Previewing Images \(page 5-22\)](#)

For information on working with lists in a Polling box, refer to the following:

➔ *Machine's Operation Guide*

### 3 Print.

[Print] > [Yes]

Printing starts.

## Checking Details

Use this procedure to check the details of an original stored in a Polling box.

**1** [FAX Box] on the Home screen > [Polling Box]

**2** Select the original.

**1** Select the document you want to check.

**2** Select [Detail].

The details of the selected document are displayed.  
Select "File Name" [Change] to rename the file.

➔ [Character Entry Method \(page 12-2\)](#)

## Deleting Originals in a Polling Box

Use this procedure to delete an original stored in a Polling box.



### NOTE

If [Delete Transmitted File] is set to [On], originals are automatically deleted following polling transmitted.

➔ [Deleting Originals After Polling Transmission \(page 5-28\)](#)

**1** [FAX Box] on the Home screen > [Polling Box]

**2** To delete.

**1** Select the document you want to delete and select [Delete].

**2** Select [Yes].

The original is deleted.

# FAX Memory RX Box

You can receive faxes to the FAX Memory RX Box, check the contents, and print only the faxes that you need.

**IMPORTANT**

**Always print faxes saved in the FAX Memory RX Box. If the box becomes full, faxes received after that will be printed.**

**NOTE**

To use the FAX Memory RX Box, set "FAX Memory RX" to [On].

For the procedure for setting, refer to the following.

➔ [FAX Memory RX \(page 8-9\)](#)

## How to print from the FAX Memory RX Box

Use the following procedure to print a fax received in the FAX Memory RX Box.



**1 Select [FAX Memory RX Box] on the Home screen.**

**2 Select the received data.**

The file is selected, a checkmark will be placed.

**NOTE**

To unselect, select the checkbox to remove the checkmark.

- To show thumbnails of fax images, select [  ].
- To show a fax image list, select [  ].
- In case of selecting [Page selection], the page can be specified.
- To show detailed information on the received faxes, select [Detail].

**3 [Preview] > Check the contents of a received fax.**

The preview screen are shown below.

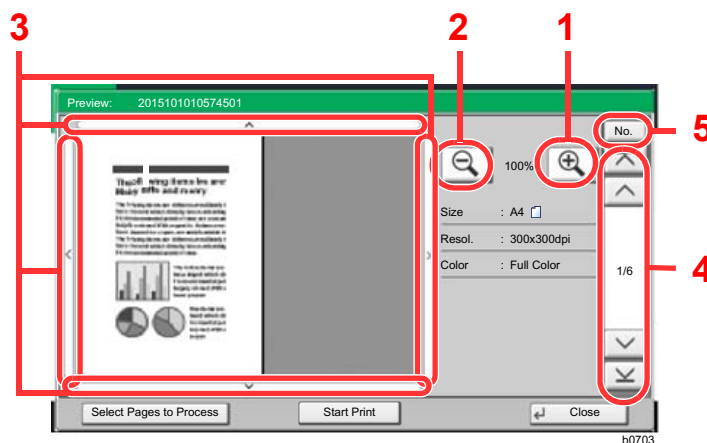

- 1 Zoom in.
- 2 Zoom out.
- 3 When you have zoomed in, you can use these keys to move the displayed area.
- 4 In multiple-page documents, you can use these buttons to change pages.
- 5 In multiple-page documents, you can change pages by entering the desired page number.

## 4 Select [Start Print].

Printing starts.



### NOTE

If you will not use preview, select the received fax you want to print > [Print].

Once the print is completed, received data in the box will be deleted automatically.

In case of selecting [Page selection] and print, unspecified pages are also deleted.

## How to delete a fax from the FAX Memory RX Box

Use the following procedure to print a fax received in the FAX Memory RX Box.

### 1 Select [FAX Memory RX Box] on the Home screen.



### 2 Select the received data.

The file is selected, a checkmark will be placed.



### NOTE

To unselect, select the checkbox to remove the checkmark.

- To show thumbnails of fax images, select [  ].
- To show a fax image list, select [  ].
- In case of selecting [Page selection], the page can be specified.
- To show detailed information on the received faxes, select [Detail].
- If you select [Preview], the preview screen of the received data is displayed.

### 3 Delete fax.

1 Select [Delete].

2 Select [Yes].

The fax will be deleted.



### NOTE

If you will not use preview, select the received fax you want to delete > [Delete] > [Yes].

# Encryption

This method allows you to communicate with originals encrypted by the sending system. Therefore, even when a third party tries to view the originals in the middle of communication by some means, the third party is prevented from knowing the actual contents of the originals. The originals received are reverted to the originals as they were before transmission (decrypted) by the receiving system, and printed. This is an extremely effective communication method for sending confidential documents that are not to be opened by a third party.

## ✓ IMPORTANT

**In order to use encryption communication, the fax of the other party needs to be an our-brand system with the same type of encryption functions.**

In encryption communication, in order to encrypt and decrypt originals, the sending and receiving systems must use the same 16-digit encryption key. When the encryption key differs between the sending system and the receiving system, the encryption cannot be conducted. Therefore, the sending system and the receiving system need to have the same encryption key and 2-digit key No. registered in advance.

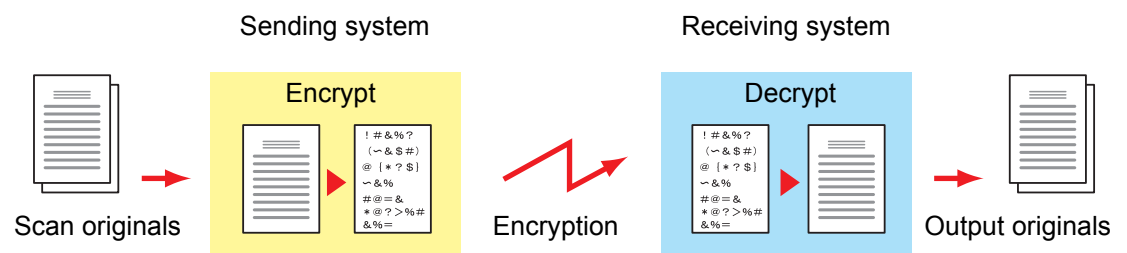

## Description of settings at sending and receiving systems

Settings	Sending system	Receiving system	Reference page
Encryption Key No.	(A) 2 digits	(B) 2 digits	<a href="#">5-38</a>
Encryption Key	(C) 16 digits	(C) 16 digits	<a href="#">5-38</a>
Key No. of Address Book (or when the number is directly dialed)	(A) 2 digits	—	<a href="#">5-39</a>
Receiving system encryption box number <sup>*1</sup>	(D) 4 digits	—	<a href="#">5-39</a>
Encryption Box No. <sup>*1</sup>	—	(D) 4 digits	—
Key No. in reception setting	—	(B) 2 digits	<a href="#">5-40</a>

<sup>\*1</sup> When the machine receives originals, the Encryption Box is not used.

## 💡 NOTE

Set the same characters for the numbers indicated by the same letter in parentheses. For example, the same characters should be used as the encryption key (C) in both the sending and receiving systems.



## Registering an Encryption Key

An encryption key is required when registering the Address Book used for encryption communication (the other party is directly entered using the numeric keys) in the sending system and when setting encryption in the receiving system.

For the creation of the encryption key, numbers from 0 to 9 and letters from A to F are arranged to form 16 numbers and/or letters arbitrarily. The created encryption key is registered with a 2-digit key No. (01 to 20).



### NOTE

Up to 20 encryption keys can be registered.

### 1 Display the screen.

[System Menu/Counter] key > [FAX] > "TX/RX Common" [Next] > "Encrypt. Key Registration" [Add/Edit]

### 2 Configure the function.

1 Select the unregistered encryption key > [Add/Edit]

2 [Encryption Key] > Enter the 16-digit encryption key > [OK] > [OK]



### NOTE

Use numbers (0 to 9) and alphabetical letters (A to F) to register the encryption key.

3 To register other encryption keys, repeat Steps 2-1 to 2-2.

### 3 Finish registration.

Select [Close].

## Changing Registration Contents of Encryption Key

### 1 Display the screen.

[System Menu/Counter] key > [FAX] > "TX/RX Common" [Next] > "Encrypt. Key Registration" [Add/Edit]

### 2 Changing.

1 Select the encryption key you want to change > [Add/Edit]

2 [Encryption Key] > Enter the 16-digit encryption key > [OK] > [OK] > [Yes]

3 To change other encryption keys, repeat steps 2-1 to 2-2.

### 3 Finish changing.

Select [Close].

## Deleting Registration Contents of Encryption Key

### 1 Display the screen.

[System Menu/Counter] key > [FAX] > "TX/RX Common" [Next] > "Encrypt. Key Registration" [Add/Edit]

### 2 Deleting.

1 Select the encryption key you want to delete, and select [Delete].

2 Select [Yes].  
This deletes the encryption key.

### 3 Finish deleting.

Select [Close].

## Using the Encrypted Transmission

When sending originals by encrypted transmission, use the Address Book registered for encryption or set encrypted transmission when dialing directly using the numeric keys.



#### NOTE

Encrypted transmission can be also used in broadcast transmission. With encryption communication, you cannot conduct sub address transmission.

### 1 Register the encryption key ahead of time.

Register the encryption key that you decided upon with the recipient.

For the procedure for registering an encryption key, refer to the following:

➔ [Registering an Encryption Key \(page 5-38\)](#)

### 2 Select [FAX] on the Home screen.

### 3 Place the originals.

### 4 Specifying destination.

Use the numeric keys to enter the destination fax number.



#### NOTE

When encrypted transmission has been set to a destination in the Address Book or One Touch Key, you can use the destination.

### 5 Turn on encrypted transmission.

1 [Detail] > "Encrypted Transmission" [Change] > [On]

2 Select the encryption key number that you used to register the encryption key that you decided upon with the recipient.

For the procedure for registering an encryption key, refer to the following:

➔ [Registering an Encryption Key \(page 5-38\)](#)

## 6 Select the encryption box.

If you need to select an encryption box, set the box.

1 [Encryption Box] > [On] > [Box No.]

2 Enter the box number (0000 to 9999) with the numeric keys.

## 7 Finish the encrypted transmission settings.

[OK] > [OK] > [OK]

## 8 Send Start.

Press the [Start] key.

The transmission will start.



### NOTE

When [On] is selected in [Dest. Check before Send], a destination confirmation screen is displayed when you press the [Start] key.

➔ [Confirmation Screen of Destinations \(page 7-13\)](#)

## Setting the Encrypted Reception

To conduct encryption communication operating the receiving system, follow the steps below.

### 1 Register the encryption key ahead of time.

Register the encryption key that you decided upon with the sender.

For the procedure for registering an encryption key, refer to the following:

➔ [Registering an Encryption Key \(page 5-38\)](#)

### 2 Display the screen.

[System Menu/Counter] key > [FAX] > "Reception" [Next]

### 3 Turn on encrypted reception.

1 "Encrypted Reception" [Change] > [On]

2 Select the encryption key number that you used to register the encryption key that you decided upon with the sender.

3 Select [OK].

The machine receives the encrypted originals from the sender of the specified encryption key.

# Using a Connected Telephone

It is possible to connect a telephone (a commercially available item) to this machine and use various functions.

## FAX/TEL Auto Switch Reception

This reception method is convenient when using both telephone and fax on a single telephone line. When fax originals have been sent, the machine automatically receives them, and when the other party is calling from a telephone, the machine makes a ringing tone urging the user to respond.

 **IMPORTANT**

**In order to use FAX/TEL Auto Switch Reception, it is necessary to connect a telephone set (commercially available product) to the machine.**

**After the telephone has made a ringing tone for the preset number of times, the other party is required to pay phone line charges even if the receiving system does not respond.**

**Flow of reception**

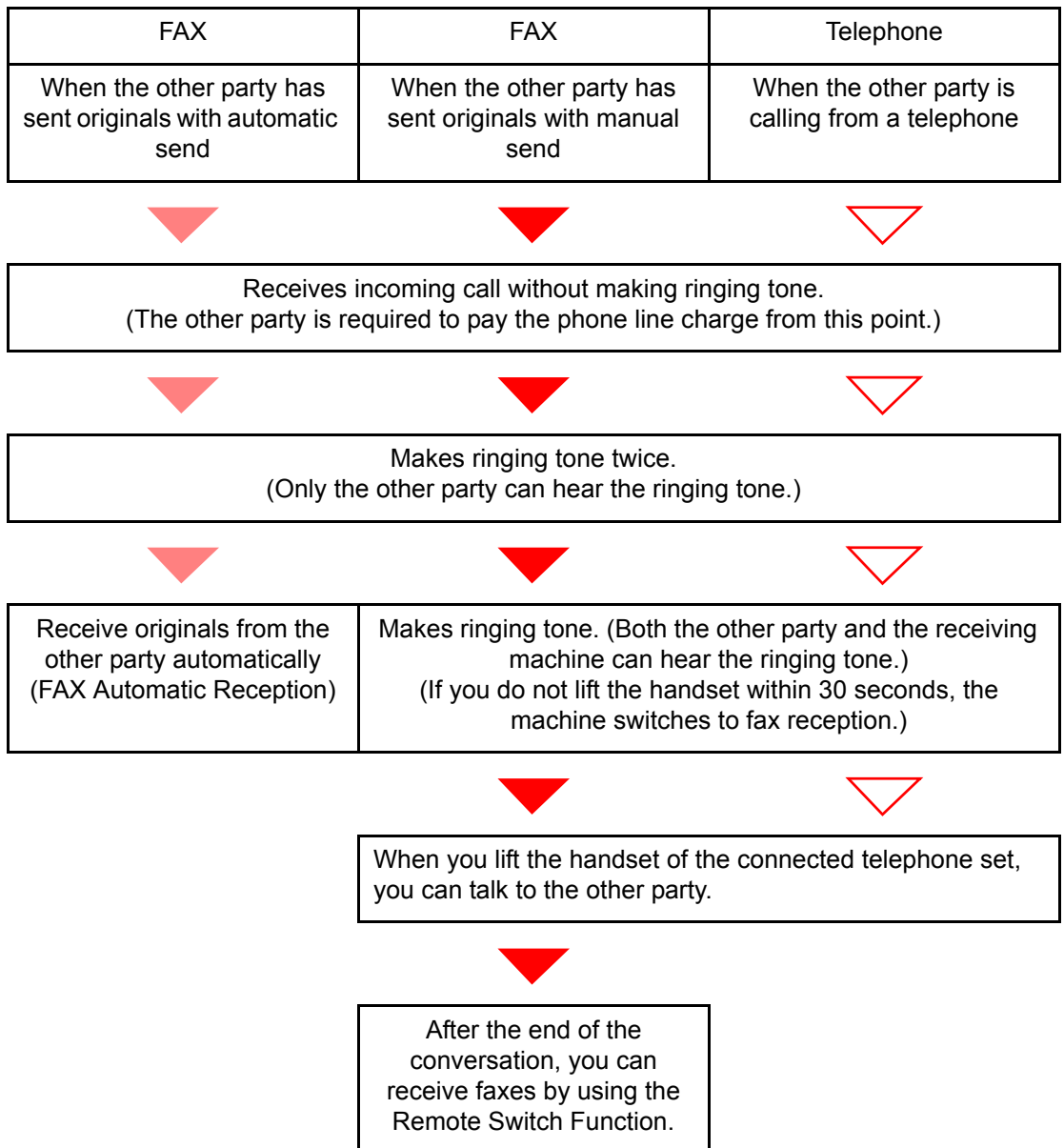



**NOTE**

At the end of the conversation, you can also receive faxes by using the Remote Switch Function.

➔ [Remote Switch Function \(page 5-49\)](#)

**Preparation:**

Select [**Auto (FAX/TEL)**].

➔ [RX Setting \(page 8-13\)](#)

**1 The telephone rings.**



The connected telephone set makes a ringing tone.



**NOTE**

You can change the number of times the ringing tone rings.

➔ [Rings\(FAX/TEL\) \(page 8-13\)](#)

**2 Answer the call.**

**When the call is from a telephone**

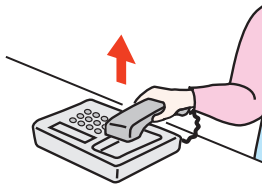

- 1 The machine makes a ringing tone urging the user to respond. Lift the handset of the telephone within 30 seconds.



**NOTE**

If you do not lift the handset within 30 seconds, the machine switches to fax reception.

- 2 Talk to the other party.



**NOTE**

At the end of the conversation, you can also receive faxes by using the Remote Switch Function.

➔ [Remote Switch Function \(page 5-49\)](#)

**When the call is from a fax**

The machine starts receiving fax originals.

## FAX/Answering Machine Auto Switch Reception

This method is convenient when using both the answering machine and fax. When fax originals have been sent, the machine receives them automatically, and when the call is from a telephone, the machine follows the functions of the connected answering machine. Therefore, when the user is absent, the other party can leave a message on the answering machine.

 **IMPORTANT**

**When using FAX/Answering Machine Auto Switch Reception function, if a silence continues for at least 30 seconds before one minute passes after the machine has received a call from the other party, the machine's silence detection function comes into operation and the machine switches to fax reception.**

 **NOTE**

In order to use FAX/Answering Machine Auto Switch Reception, it is necessary to connect an answering machine-equipped telephone set (commercially available product) to the machine.

For details, such as responding to messages, refer to the Operation Guide of each answering machine.

Set the number of rings to be made by the machine more than the number of rings to be made by the answering machine.

➔ [Rings \(TAD\) \(page 8-13\)](#)

**Flow of reception**

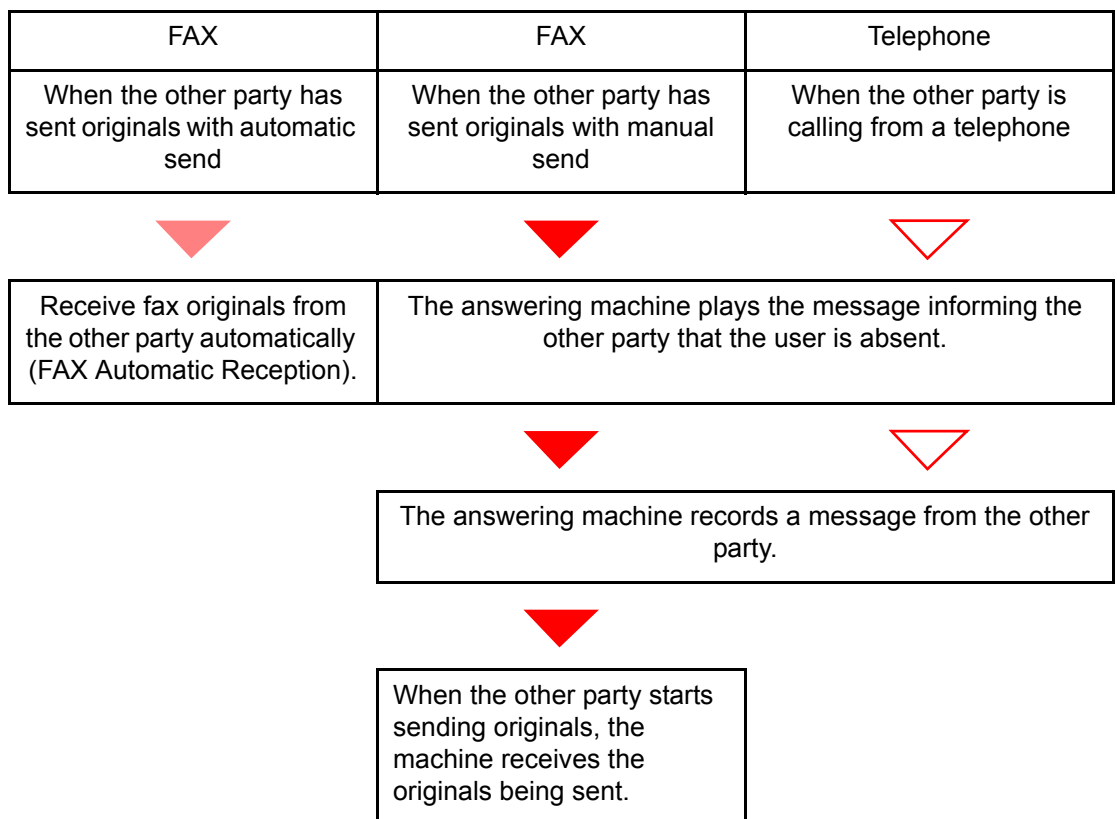

**Preparation:**

Select [**Auto (TAD)**].

➔ [RX Setting \(page 8-13\)](#)

## 1 The telephone rings.



The connected telephone set makes ringing tone the set number of times.



### NOTE

If you lift the handset while the telephone set is still making the ringing tone, the machine enters a status the same as manual reception.

➔ [Manual Reception \(page 5-48\)](#)

## 2 The answering machine responds.

### When the call is from a telephone, but the user is absent

The answering machine plays a response message, and starts recording the other party's message.



### NOTE

When silence continues for at least 30 seconds during recording, the machine switches to fax reception.

### When the call is from a fax

The machine starts receiving fax originals.

## DRD Reception (Available for some countries.)

This reception mode utilizes the Distinctive Ring Pattern service available through some telephone companies. With this service, you can use two or more fax numbers on a single telephone line. Thus, you can use this fax and a telephone on the same line, and you can still designate a different fax number for each of them. As each number is given a different ring pattern, the machine is able to differentiate between incoming calls. If one of these numbers is designated for the machine, and a desired ring pattern is designated for that number in advance, fax reception will be initiated automatically whenever the machine detects the ring pattern distinctive to the fax.



### NOTE

Using DRD Reception to receive a telephone call is only possible if a separately purchased telephone is connected to the machine. DRD reception is only possible if you subscribe to the Distinctive Ring Pattern service provided by your telephone company. Contact your telephone company for further information on the Distinctive Ring Pattern service available.

### Flow of reception

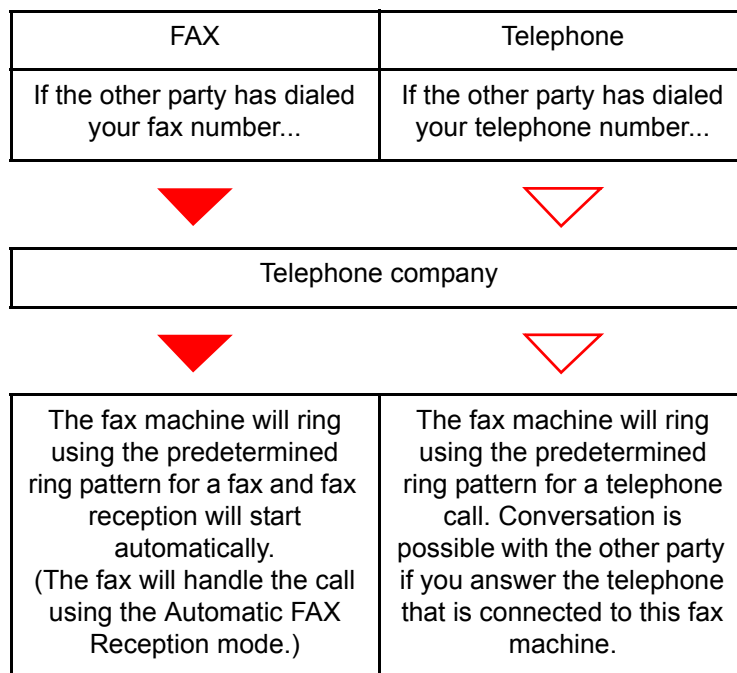

### Preparation:

Select **[Auto (DRD)]**.

➔ [RX Setting \(page 8-13\)](#)



## 1 The telephone rings.



When a call comes in, the telephone will ring.



### NOTE

If you lift the handset while the telephone is still ringing, the machine will deal with the call in the same manner as standard Manual FAX Reception.

➔ [Manual Reception \(page 5-48\)](#)

## 2 Answer the call.

The machine will then ring using the predetermined ring pattern.

### When the call is from a telephone

Lift the handset and speak with the other party. When the conversation is over, fax reception can be initiated manually.

### When the call is from a fax

Once the ringing tone stops, fax reception will start automatically.

## Manual Send

When you want to talk to the person at the receiving system or the receiving system needs to switch to fax, use this method to send originals.

**1 Place the originals.**

**2 Dial the destination.**

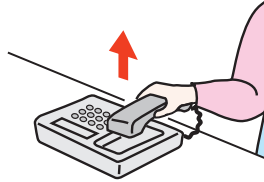

Lift the handset, and dial the number of the receiving system.

**3 Check if the telephone line has connected to the fax of the receiving system.**

If the destination is a fax machine, you will hear a long high beep sound. If a person answers, you can talk to that person.

**4 [FAX] on the Home screen > [On Hook]**

**5 Press the [Start] key.**

Transmission begins.

**6 Replace the handset.**

When sending starts (when the **[Processing]** indicator on the operation panel starts blinking), return the handset to its original position.

## Manual Reception

Reception is possible after confirming that the telephone line has connected to the sending party.



### NOTE

FAX Automatic Reception has been preset for the receiving mode of this machine. To use Manual Reception, you need to change the receiving mode to Manual Reception. To change to manual mode, refer to the following:

➔ [RX Setting \(page 8-13\)](#)

### 1 The telephone rings.

When there is an incoming call, the telephone connected to the machine makes a ringing tone.

### 2 Lift the handset.

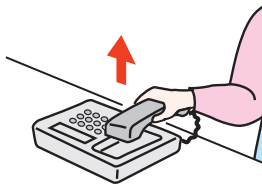

Lift the handset of the telephone.

### 3 Check if the telephone line has connected to the fax of the sending system.

If the destination is a fax machine, you will hear soft beep sounds. If a person answers, you can talk to that person.

### 4 [FAX] on the Home screen > [On Hook] > [Manual RX]

Reception will start.



### NOTE

When using a telephone set that can send tone signals, use the telephone to start the reception of originals with the remote switch function.

➔ [Remote SW Dial \(page 8-13\)](#)

### 5 Replace the handset.

When reception starts (when the [**Processing**] indicator on the operation panel starts blinking), return the handset to its original position.

## Remote Switch Function

You can start fax reception by operation from the connected telephone set. This function is convenient for using this machine and a telephone set (commercially available product) in combination installed at places distant from each other.



### NOTE

In order to use remote switch, it is necessary to connect the tone signal-sending telephone set (commercially available product) to the machine. However, even if it is a tone signal-sending telephone set, this function may not be used satisfactorily depending on the type of telephone set. For details, contact our agent or the store where you purchased this machine.

The remote switch dial is set to 55 at the factory.

The remote switch dial number can be changed.

➔ [Remote SW Dial \(page 8-13\)](#)

### Using the Remote Switch Dial

To start fax reception by operation from the connected telephone set, use the following operation.

#### 1 The connected telephone set makes a ringing tone.

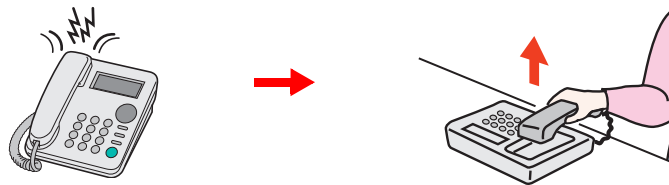

Lift the handset of the telephone.



### NOTE

You can change the number of times the ringing tone rings.

➔ [Rings\(Normal\) \(page 8-13\)](#)

#### 2 Press the remote switch dial number (2 digits).

When you hear the fax tone from the handset, enter the two-digit remote switch dial number using the dial button on the telephone set. The telephone line switches to the machine, and reception starts.

# 6 Sending Faxes from PC

This chapter explains the following topics:

Flow of Network FAX Sending .....	6-2
Flow of Network FAX Receiving .....	6-2
Setup .....	6-3
Installing the FAX Driver .....	6-4
Uninstalling the FAX Driver .....	6-6
Basic Transmission .....	6-7
Configuring the Driver Default Settings .....	6-10
Default Settings Dialog Box .....	6-11
Changing Transmit Settings .....	6-15
Using Cover Pages .....	6-20
Cover Page Registration (Default Settings) .....	6-26
Transmission Control .....	6-32

The Network FAX function enables any PC, which is networked to the machine, to perform sending and receiving of faxes. Its primary features include the following.

- PC-prepared document can be sent and received by fax without being printed out.
- An Address Book (in the machine/PC) can be used to specify a desired destination.
- Addition of a cover page.
- Transmission and printing can be done simultaneously.
- E-mail reporting of the transmission result.
- Sub address transmission is available.
- Operation is as simple as printing.

## Flow of Network FAX Sending

Network FAX sending is performed in the following sequence.

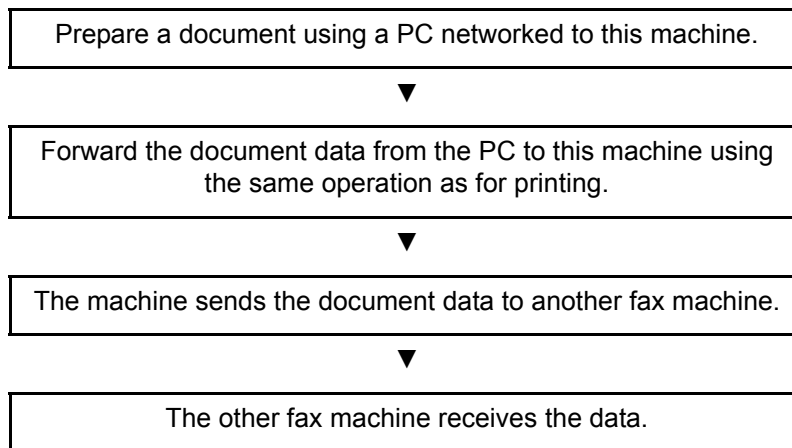

## Flow of Network FAX Receiving

Network FAX receiving is performed in the following sequence.

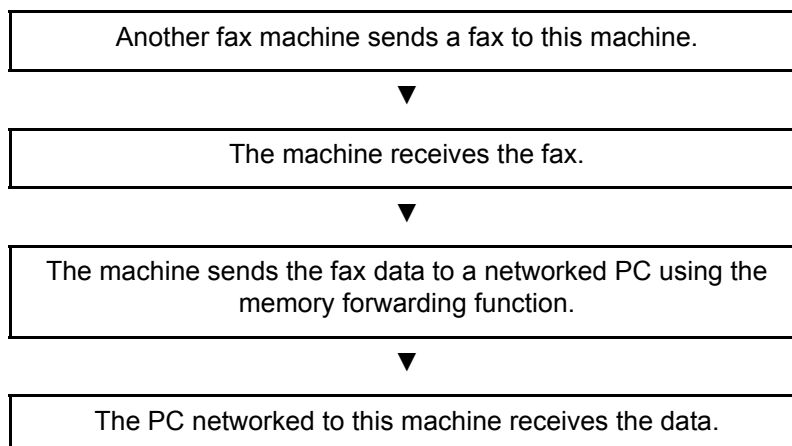

### NOTE

The memory forwarding function allows not only reception by the networked PC, but also forwarding of the received fax by e-mail or forwarding to another fax machine.

# Setup

The following preparation is needed before using Network FAX.

## Connection to a PC

Connect the machine and PC to the network using a network cable.

➔ *Machine's Operation Guide*

## Machine Registration

Using the memory forwarding function, select the recipient PC or file format.



### NOTE

You can forward the received fax to the PC or forward it as an e-mail attachment.

➔ [Memory Forwarding \(page 5-2\)](#)

## Installing the FAX Driver

The procedure for installing the FAX Driver is explained below. (The screens in Windows 10 are shown.)

### 1 Insert the **Product Library disc**.

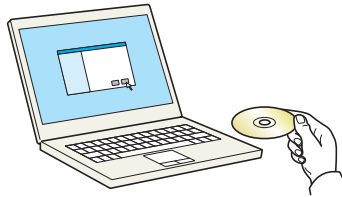

#### NOTE

Installation on Windows must be done by a user logged on with administrator privileges.  
If the "Welcome to the Found New Hardware Wizard" dialog box displays, select [**Cancel**].  
If the autorun screen is displayed, click [**Run Setup.exe**].  
If the user account management window appears, click [**Yes**].

### 2 Display the screen.

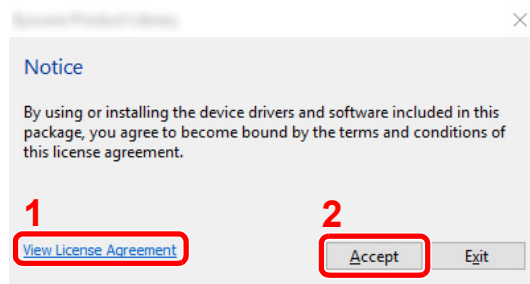

- 1 Click [**View License Agreement**] and read the License Agreement.
- 2 Click [**Accept**].

After clicking [**Accept**] in the license dialog box, depending on your region, a message about resource and energy conservation may appear. Read the message and click [**OK**].

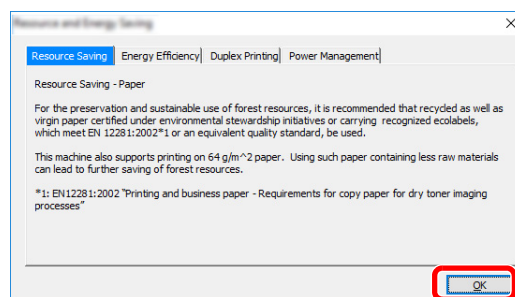

After installation is successful, "Set Duplex as default" appears and is selected on the Finished page. The driver is set to duplex mode by default.

### 3 Select **Custom Install**.

Select [**Custom Install**].



## 4 Select FAX Driver.

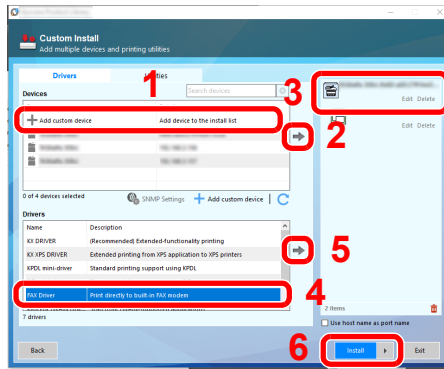

- 1 Select the device to be installed.
- 2 Click [➡].
- 3 Select the product to be installed.
- 4 Select **[FAX Driver]**.
- 5 Click [➡].
- 6 Click **[Install]**.



### NOTE

The machine cannot be detected unless it is on. If the computer fails to detect the machine, verify that it is connected to the computer via a network cable and that it is turned on and click **C** (Refresh).

If the Windows security window appears, click **[Install this driver software anyway]**.

## 5 Finish the installation.

If a system restart message appears, restart the computer by following the screen prompts. This completes the FAX driver installation procedure.

## Uninstalling the FAX Driver

Perform the following procedure to delete the FAX Driver from your computer.



### NOTE

Uninstallation on Windows must be done by a user logged on with administrator privileges.

### 1 Display the screen.

Click **[Search]** in charms, and enter "Uninstall Kyocera Product Library" in the search box. Select **[Uninstall Kyocera Product Library]** in the search list.



### NOTE

- In Windows 8.1, click **[Search]** in charms, and enter "Uninstall Kyocera Product Library" in the search box. Select **[Uninstall Kyocera Product Library]** in the search list.
- In Windows 7, click **[Start]** button on the Windows and then select **[All Programs]**, **[Kyocera]**, and **[Uninstall Kyocera Product Library]** to display the Uninstall Wizard.

### 2 Uninstall the software.

Place a check in the check box of the driver to be deleted and click **[Uninstall]**.

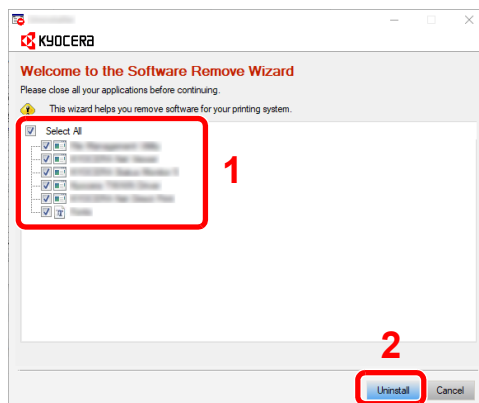

### 3 Finish uninstalling.

If a system restart message appears, restart the computer by following the screen prompts. This completes the software uninstallation procedure.



### NOTE

The software can also be uninstalled using the Product Library.

In the Product Library screen, select to uninstall, and follow the on-screen instructions to uninstall the software.

# Basic Transmission

This section explains the basic procedure for sending a fax by Network FAX. An Adobe Acrobat document is sent as an example.

## 1 Create the document to be sent.

- 1 Use an application on your computer to create the document to be sent.
- 2 Set the original size and orientation.
- 3 Select **[Print]** from the File menu. The Print dialog box for the application that you are using will appear.

## 2 Select settings in the Print dialog box.

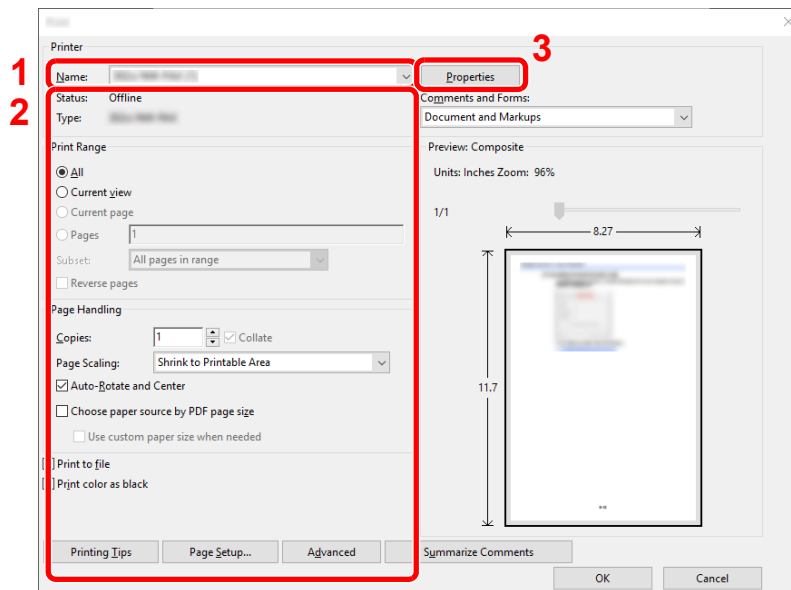

- 1 Select the product name of the machine (XXX XXX NW-FAX) to be used in the printer name list.
- 2 Set the print range and other settings.



### NOTE

Make sure that the number of copies is set to 1. The following screen is an example. The actual dialog box will vary depending on the application that you are using.

- 3 Click **[Properties]** to open the Properties window.

### 3 Select settings on the FAX Setting tab.

- 1 Specify fax settings such as the original size on the FAX Setting tab, and click [OK].

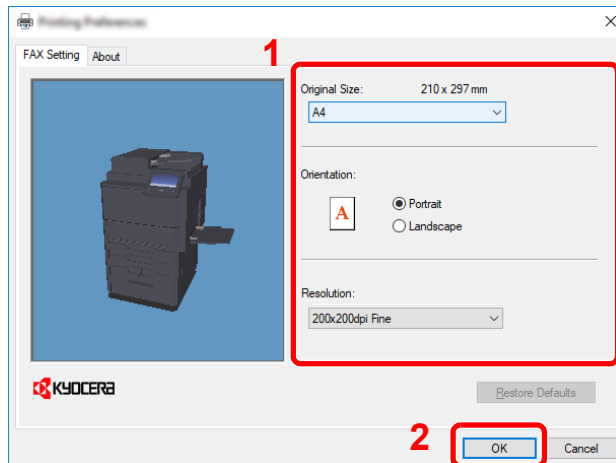

#### NOTE

The image of the screen varies between models.

For detailed information on the settings on the tab, refer to the following:

- ➔ [Configuring the Driver Default Settings \(page 6-10\)](#)

- 2 You will return to the Print dialog box for the application. Click [Print]. The Transmit Settings dialog box will appear.

### 4 Select settings in the Transmit Settings dialog box.

You can specify settings such as a transmission time or a sub-address in the Transmit Settings dialog box.

For details on the settings, refer to the following:

- ➔ [Changing Transmit Settings \(page 6-15\)](#)

### 5 Specify a cover page.

To include a cover page, select settings on the [Cover Page] tab.

For details on the settings, refer to the following:

- ➔ [Using Cover Pages \(page 6-20\)](#)

## 6 Set the destination.

- 1 Use the keyboard to enter the destination fax number in the **[Address Setting]** tab.  
 If you are using the optional Internet fax function, select the mode that you want to use (**[FAX]**, **[i-FAX (Via server - On)]**, or **[i-FAX (Via server - Off)]**) from "Transmission Mode", and enter the fax number or address of the other machine.
  - Maximum number of characters that can be entered: 64 characters
  - Characters that can be entered: 0 to 9, #, \*, -, space (a space or "-" CANNOT be entered as the first character)
- 2 Click **[Add to Destination List]**. The destination information will appear in the address list. To send to multiple destinations, repeat this operation.
- 3 To use the Address Book, click **[Select from Address Book]** and select the destination.

Address Setting | Cover Page | Option | Sender Information | Internet FAX

Transmission Mode: FAX

FAX Number:  
0123456789

Option Settings...

Add to Destination List

Destination List: Select from Address Book... 0 Items / Remaining 500 Items

Address	Company	Department	Name

Edit... Delete Delete All

Help Send Cancel



### NOTE

If **[Broadcast]** is set to **[Prohibit]**, it is not possible to enter multiple destinations.

➔ *Machine's Operation Guide*

## 7 Click **[Send]**. Transmission will begin.

## Configuring the Driver Default Settings

Use the FAX Setting tab of the print settings screen to set the original size and other transmission conditions.

### 1 Display the screen.

- 1 Click **[Start]** button on the Windows and then select **[Windows System]**, **[Control Panel]**, and **[View devices and printers]**.



#### NOTE

- In Windows 8.1, select **[Settings]** in charms on Desktop, and select **[Control Panel]**, and then **[Devices and Printers]**.
- In Windows 7, click **[Start]** button on the Windows, and then click **[Devices and Printers]**.

- 2 Right-click the product name of the machine you are using and select **[Printing preferences]** from the drop-down menu. The Printing Preferences screen will open.

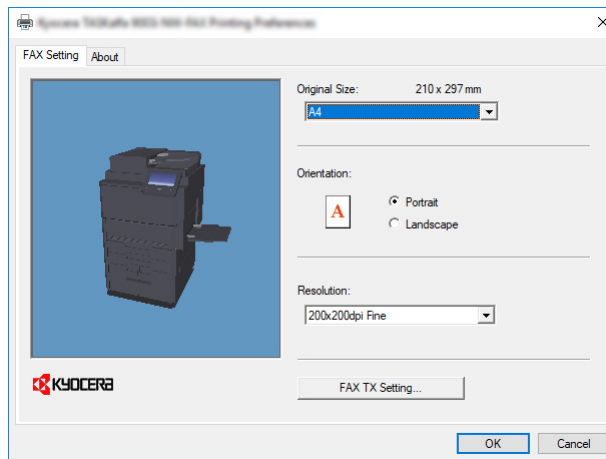

#### NOTE

The image of the screen varies between models.

### 2 Select settings.

The following settings can be specified.

Item	Description
Original Size	Select the size of the document being transmitted from the drop-down list. <b>Available settings:</b> Letter, Legal, Ledger (11 x 17), Statement, A3, A4, A5, Folio, B4 and B5(JIS)
Orientation	Specify whether the orientation of the document is portrait or landscape. <b>Available settings:</b> Portrait, Landscape
Resolution	Select the resolution of the document to be transmitted from the drop-down list. <b>Available settings:</b> 100 x 200 dpi Normal, 200 x 200 dpi Fine, 400 x 400 dpi Ultra fine, 600 x 600 dpi
FAX TX Setting	Click <b>[FAX TX Setting]</b> to change the default settings for fax transmission. The Default Settings dialog box will appear.

## Default Settings Dialog Box

By setting the transmission conditions that you use most in this dialog box, you can minimize the need to change the settings each time.

The Default Settings dialog box can be accessed by the following procedure:

### 1 Display the screen.

- 1 Click **[Start]** button on the Windows and then select **[Windows System]**, **[Control Panel]**, and **[View devices and printers]**.



#### NOTE



- In Windows 8.1, select **[Settings]** in charms on Desktop, and select **[Control Panel]**, and then **[Devices and Printers]**.
- In Windows 7, click **[Start]** button on the Windows, and then click **[Devices and Printers]**.

- 2 Right click the name of the machine to be used as the network fax and select **[Printing preferences]** from the resulting drop-down menu. Click the **[FAX TX Setting]** button in the **[Printing Preferences]** window.

### 2 Configure the settings.

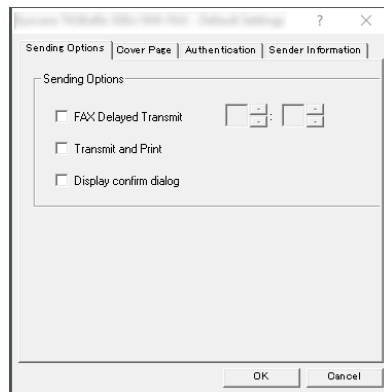
- (1) Sending Options Tab



Item	Description
<b>FAX Delayed Transmit</b> checkbox	<p>Check the checkbox in order to activate the time fields to the right of the checkbox whenever you want to set the time that your documents will be transmitted. The desired time setting can be entered directly with the keyboard or by clicking on the ▲ and ▼ arrows.</p> <p> <b>IMPORTANT</b> If the time that is shown in the message display of this fax machine does not match the current time, communications that use the timer may not be accomplished as expected. If the displayed time is not current, be sure to adjust it to match the correct time.</p> <p> <b>NOTE</b> If you designate a time that is earlier in the day than the time that is actually displayed in the fax machine itself, the transmission operation will be carried out the following day at that time. Be sure to confirm the time setting in the fax machine itself before making this setting.</p> <p>Value: 00:00-23:59</p>
<b>Transmit and Print</b> checkbox	Check the checkbox when you want to print out the documents at the fax machine same time as you send them by fax.
<b>Display confirm dialog</b> checkbox	You can check the checkbox to display the destination confirmation screen and check the destinations before transmission.

(2) Cover Page Tab

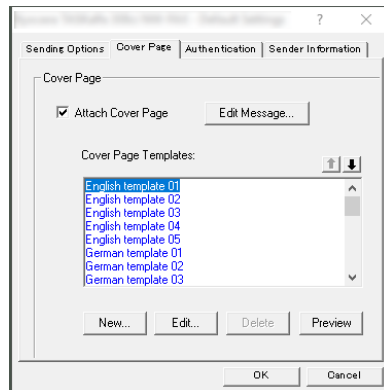

Item	Description
<b>Attach Cover Page</b> checkbox	Check the checkbox when you want to add a cover page to your transmission.

 **NOTE**

For information regarding the Cover Page registration method, refer to the following:

➔ [Cover Page Registration \(Default Settings\) \(page 6-26\)](#)



(3) Authentication Tab

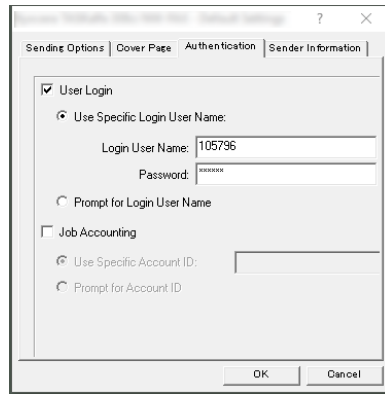

Item	Description
<p><b>User Login</b> checkbox</p>	<p>If the fax machine is set to User Login, select either <b>Use Specific Login User Name</b> or <b>Prompt for Login User Name</b> as desired.  <b>Use Specific Login User Name:</b> Enter the Login User Name and Password. Transmission will be performed using the entered Login User Name and Password.  <b>Prompt for Login User Name:</b> A screen for entering the Login User Name and Password will be displayed when attempting a transmission. The Login User Name and Password must be entered each time a transmission is attempted.</p>
<p><b>Job Accounting</b> checkbox</p>	<p>If the fax machine is set to Job Accounting, select either <b>Use Specific Account ID</b> or <b>Prompt for Account ID</b> as desired.  <b>Use Specific Account ID:</b> Enter the Account ID. Transmission will be performed using the entered Account ID.  <b>Prompt for Account ID:</b> A screen for entering the Account ID will be displayed when attempting a transmission. The Account ID must be entered each time a transmission is attempted.</p>

(4) Sender Information Tab

Enter your own information into fields explained below to send a cover page with your faxes.

Item	Description
<b>Company</b>	A maximum of 64 characters can be entered.
<b>Department</b>	A maximum of 64 characters can be entered.
<b>Name</b>	A maximum of 32 characters can be entered.
<b>Telephone Number</b>	A maximum of 20 characters can be entered. (Entry is allowed for the characters 0 to 9, #, *, -, (, ), +, and spaces.)
<b>FAX Number</b>	A maximum of 20 characters can be entered. (Entry is allowed for the characters 0 to 9, #, *, -, (, ), +, and spaces.)
<b>E-mail Address</b>	A maximum of 256 characters can be entered. Available characters: Symbols ( !, #, \$, %, &, ', *, +, -, ., /, =, @, [, ], ^, _, ` , { and } ) Alphanumerics ( 0 – 9, A – Z and a – z )

 **NOTE**

Entering the e-mail address makes it possible to receive the transmission results report by e-mail. The fax machine must be set to transmit e-mail.

➔ *Machine's Operation Guide*

## Changing Transmit Settings

Transmit Settings can be changed at the time of transmission.

### (1) Selecting a Destination from the Address Book

There are two types of Address Books from which you can select the party to transmit to. They are the fax machine's Address Book and Windows Address Book.



#### NOTE

There are three types of Address Books from which you can select the party to transmit to. They are the fax machine's Address Book, Windows Address Book, and the Address Book for the Network FAX data file (.fdt).

When using the fax machine's Address Book, the party must be registered in the fax machine's Address Book.

➔ [Registering Destinations in the Address Book \(page 2-16\)](#)

### 1 Click the [Select from Address Book] button.

The Address Selection dialog box opens.

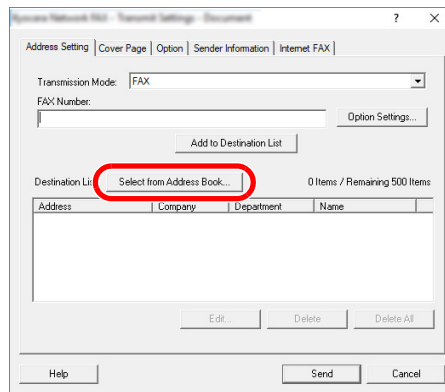

### 2 Select the desired Address Book.

To select the Address Book registered in the fax machine, select [**Address Book/XXXX (model name)**] from the drop-down menu.



#### NOTE

To use the Windows Address Book, select [**Windows Address Book**].

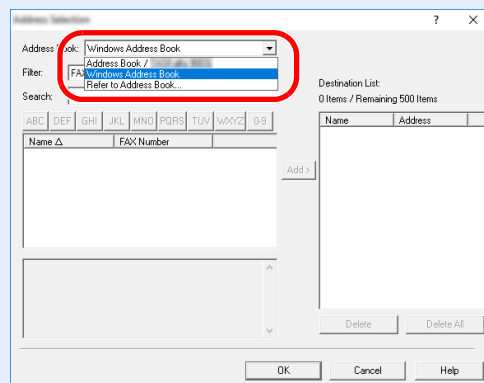

For adding an Address Book for Network FAX data file (.fdt), select the [**Refer to Address Book**], click on the [**Add**] button, and then select the [**Address Book data file**].

### 3 Select the Destination.

The destinations registered in the Address Book are shown in the list on the left side of the dialog box. To select an Internet fax destination or a group of destinations, select [**i-FAX (Via server - On)**], [**i-FAX (Via server - Off)**], or [**Group**] from the filter's pull-down menu.

Select the desired destination and click on the [**Add>**] button. The selected destination will be added to the [**Destination List**] (right side).

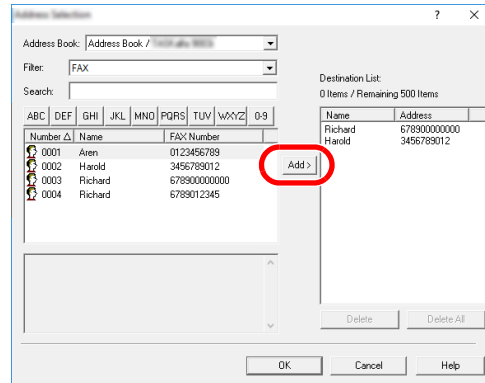

#### NOTE

- The list can be sorted. Click on the list item by which you want to sort the list (Number, Name, Fax Number).  $\Delta$  or  $\nabla$  are displayed next to the sorted items. In addition, the corresponding destinations can be selected using the sorted items by entering a search character string in the Search field.
- When a destination is selected, the destination details are displayed in the field at the bottom of the list. When a group is selected, the members of the group are displayed in the field at the bottom of the list.
- If [Broadcast] is set to [Prohibit], it is not possible to enter multiple destinations.

➔ *Machine's Operation Guide*

To delete any of the destinations from the Destination List, select that destination and then click on the [**Delete**] button. To delete all of the destinations from the Destination List, click on the [**Delete All**] button.

### 4 Click on the [OK] button.

The [**Transmit Settings**] dialog box will be displayed once again.

## (2) Subaddress-Based Communication



### NOTE

In order to conduct sub address communication, the other party's system also needs to be equipped with sub address communication functions of the same type.

### 1 Open the Option Settings dialog box.

Click on the [Option Settings] button in the [Address Setting] tab of the [Transmit Settings] dialog box.

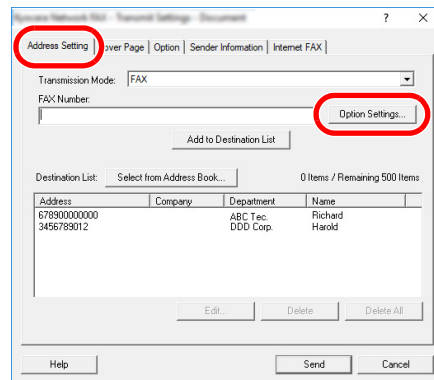

### 2 Enter the sub-address and password as it is registered in the destination fax.

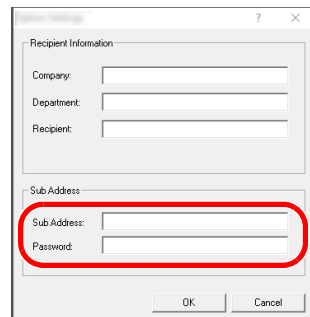

- Maximum number of characters that can be entered: 20 characters
- Characters that can be entered: 0 to 9, #, \*, space (a space CANNOT be entered as the first character)

### 3 Click on the [OK] button.

The [Transmit Settings] dialog box will be displayed once again.

### (3) Cover Page Settings

A Cover Page can be set as the first page of a fax transmission. In addition to the standard templates for Cover Pages, original templates can be created and used.

To attach and transmit a Cover Page, place a check in the check box for **[Attach Cover Page]** in the **[Cover Page]** tab.

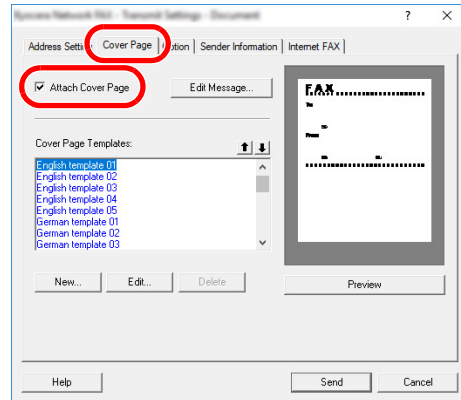

For information regarding how to use Cover Pages, refer to the following:

➔ [Using Cover Pages \(page 6-20\)](#)

### (4) Optional Settings

The settings that were selected in “(1) Sending Options Tab” can be changed by clicking the **[Option]** tab.

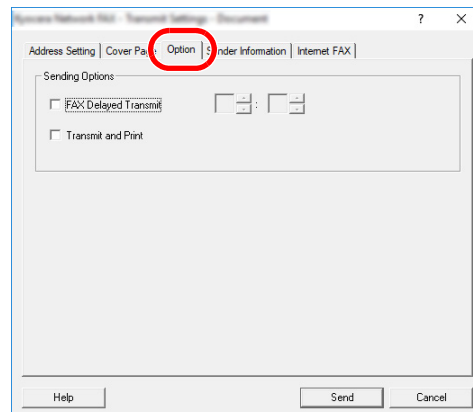

For the setting procedures, refer to the following:

➔ [\(1\) Sending Options Tab \(page 6-11\)](#)

## (5) Transmitting Terminal Information Data

The settings that were selected in “(4) Sender Information Tab” can be changed by clicking the [Sender Information] tab.

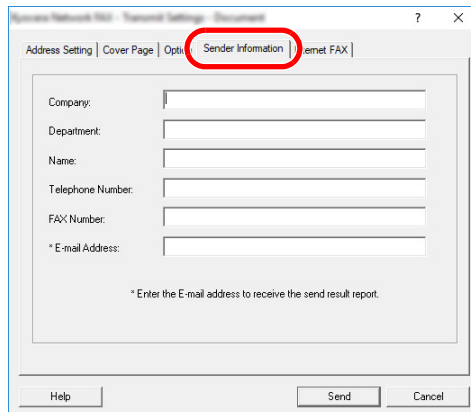
A screenshot of the 'Terminal Settings' dialog box. The 'Sender Information' tab is selected and highlighted with a red circle. The dialog box contains several input fields: 'Company:', 'Department:', 'Name:', 'Telephone Number:', 'FAX Number:', and '\* E-mail Address:'. Below the fields, there is a note: '\* Enter the E-mail address to receive the send result report.' At the bottom of the dialog box, there are three buttons: 'Help', 'Send', and 'Cancel'.

For the setting procedures, refer to the following:

➔ [\(4\) Sender Information Tab \(page 6-14\)](#)

## (6) Internet fax Setting

For Internet fax transmission, click on the [Internet FAX] tab and enter the Subject and the message.

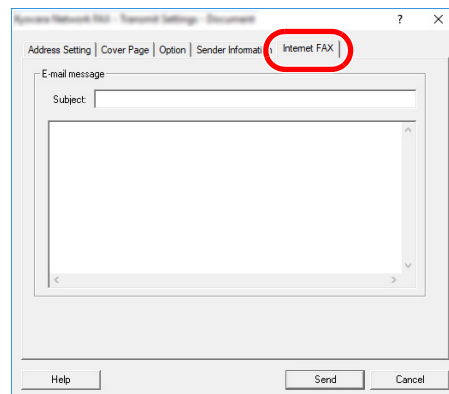
A screenshot of the 'Terminal Settings' dialog box. The 'Internet FAX' tab is selected and highlighted with a red circle. The dialog box contains an 'E-mail message' section with a 'Subject:' label and a text input field. Below the subject field is a large text area for the message. At the bottom of the dialog box, there are three buttons: 'Help', 'Send', and 'Cancel'.

**Subject:** A maximum of 60 characters can be entered.

**Message:** A maximum of 500 characters can be entered.



### NOTE

If the other machine is set to print a cover page, the subject and message are printed.

## Using Cover Pages

### Cover Page Selection (Transmission Settings)

The Cover Page is attached to the fax and sent as the first page.

#### About Cover Pages

The Cover Page can be selected from a template. The Cover Page contains such destination information and sender information as that shown below.

#### Sample of English template 01

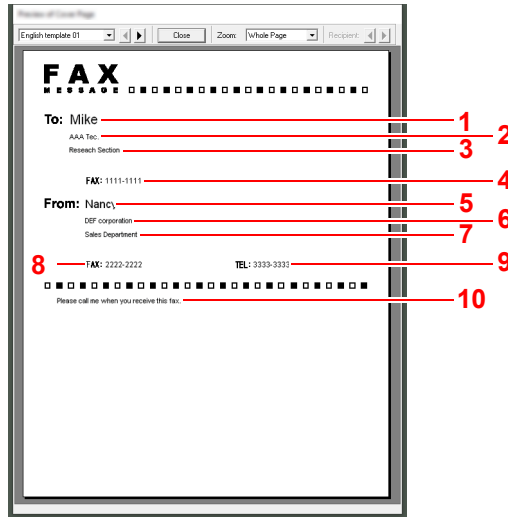

No.	Item
1	Recipient Name
2	Destination Company Name
3	Destination Department Name
4	Destination Fax number or Internet Fax Address
5	Sender Name
6	Sender Company Name
7	Sender Department Name
8	Sender Fax Number
9	Sender Telephone Number
10	Message



## Attaching and Transmitting a Cover Page

The procedure for attaching and transmitting a Cover Page is shown below.

### 1 Open the Transmit Settings dialog box.

Perform Steps 1 to 6 of the Basic Transmission method to display the Transmit Settings dialog box.

➔ [Basic Transmission \(page 6-7\)](#)

When selecting the destination from an Address Book, refer to “(1) Selecting a Destination from the Address Book”, select the destination, and go to Step 4.

➔ [\(1\) Selecting a Destination from the Address Book \(page 6-15\)](#)

### 2 Enter the fax number.

In the [Address Setting] tab, enter the destination fax number and click on the [Option Settings] button.



#### NOTE

For internet fax transmission via mail server, select [i-FAX (Via server - On)] from Transmission Mode and enter the Internet fax address.

For internet fax transmission without mail server, select [i-FAX (Via server - Off)] from Transmission Mode and enter the Internet fax address.

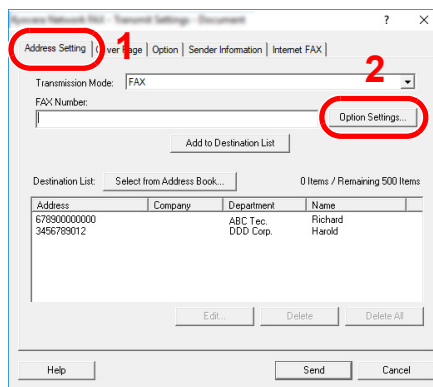

Item	Description
<b>FAX Number</b>	A maximum of 64 characters can be entered.
<b>Internet FAX Address</b>	A maximum of 256 characters can be entered.

### 3 Enter the recipient information.

When finished, click the **[OK]** button.

Item	Description
<b>Company</b>	A maximum of 32 characters can be entered.
<b>Department</b>	A maximum of 32 characters can be entered.
<b>Recipient</b>	A maximum of 32 characters can be entered.



#### NOTE

When **[Attach Cover Page]** of the **[Cover Page]** Tab is not set, the Cover Page Confirmation screen will be displayed.

To include a cover page, click on **[Attach Cover Page]** button.

### 4 Add the destination to the destination list.

- 1 Add this information to the **[Destination List]** by clicking on the **[Add to Destination List]** button.
- 2 To change the recipient information of a destination that has been added to the **[Destination List]**, select the destination to be changed and click on the **[Edit]** button. Change the recipient information and click on the **[OK]** button.

Item	Description
<b>FAX Number (Internet FAX Address)</b>	The fax number or the internet fax address cannot be changed.
<b>Company</b>	A maximum of 32 characters can be entered.
<b>Department</b>	A maximum of 32 characters can be entered.
<b>Recipient</b>	A maximum of 32 characters can be entered.

- 3 When the sender information is not set in the [Default Settings] dialog box, click on the [Sender Information] tab and set the sender information.

➔ (4) Sender Information Tab (page 6-14)

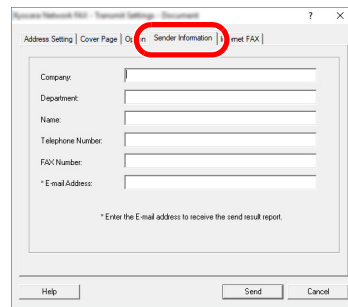

Item	Description
<b>Company</b>	A maximum of 64 characters can be entered.
<b>Department</b>	A maximum of 64 characters can be entered.
<b>Name</b>	A maximum of 32 characters can be entered.
<b>Telephone Number</b>	A maximum of 20 characters can be entered. (Entry is allowed for the characters 0 to 9, #, *, -, +, and spaces.)
<b>FAX Number</b>	A maximum of 20 characters can be entered. (Entry is allowed for the characters 0 to 9, #, *, -, +, and spaces.)
<b>E-mail Address</b>	A maximum of 256 characters can be entered. Available characters: Symbols ( !, #, \$, %, &, ', *, +, -, ., /, =, @, [, ], ^, _ , ` , { and } ) Alphanumerics (0 – 9, A – Z and a – z)

## 5 Attach a Cover Page.

Click on the [Cover Page] tab and place a check in the [Attach Cover Page] checkbox.

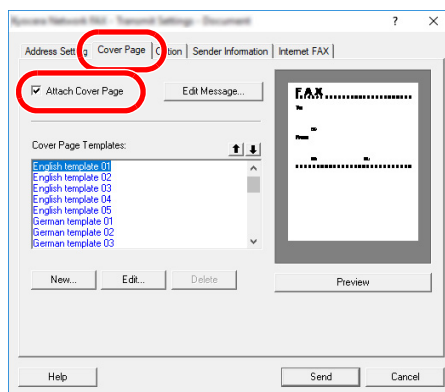

## 6 Select the Cover Page to be attached.

Select a Cover Page template from the [Cover Page Templates] list.



### NOTE

If the Cover Page is registered in the Default Settings, then the action of selecting the Cover Page for each transmission can be omitted.

➔ [Cover Page Registration \(Default Settings\) \(page 6-26\)](#)

Original Cover Page templates can be created.

➔ [Creating New Cover Page Templates \(page 6-28\)](#)

## 7 Check the contents of the Cover Page.

- 1 Click on the [Preview] button. A preview of the currently selected template will be displayed.

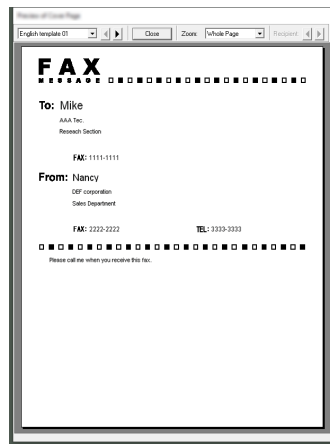

To display a different template, use the drop-down menu at the top of the dialog box or click on the [◀] or [▶] button. The template display magnification can also be changed within the range of 25 to 250% from the drop-down menu.



### IMPORTANT

**Before transmitting the fax, be sure to use the Preview screen to check all of the displayed information including the recipient name and company name. If there is a large number of characters for information that is automatically entered, they might not completely fit in the field and the characters might not print correctly. If the characters are not displayed correctly, reduce the number of characters in the recipient information or sender information or edit the template being used.**

- 2 Click on the [Close] button.

## 8 Edit the Message.

- 1 Click on the [Edit Message] button.

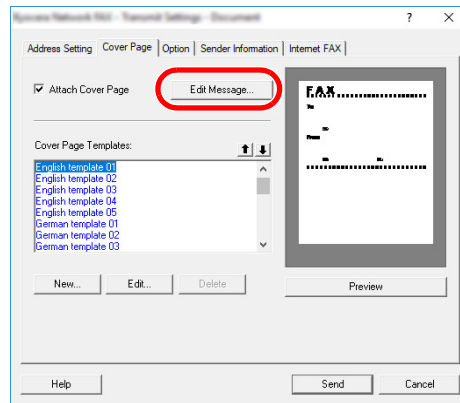

- 2 Enter the message to be added to the Cover Page and click on the [OK] button.

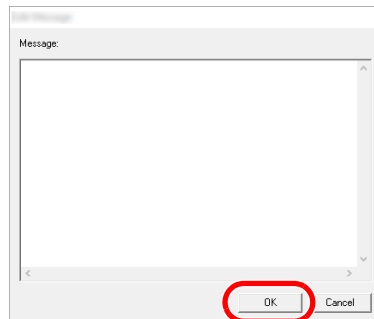

Item	Description
Message	A maximum of 1,000 characters can be entered.

## 9 Transmit.

- Click on the [Send] button to begin the transmission.

## Cover Page Registration (Default Settings)

If the Cover Page is registered in the Default Settings, the action of selecting the Cover Page for each transmission can be omitted.

### Template Selection

Select the Cover Page template to be registered in the Default Settings. The registration method is as follows.

#### 1 Open the Default Settings dialog box.

Perform the Default Settings Dialog Box procedure, open the [Default Settings] dialog box.

➔ [Default Settings Dialog Box \(page 6-11\)](#)

#### 2 Attach a Cover Page.

Click on the [Cover Page] tab and place a check in the [Attach Cover Page] checkbox.

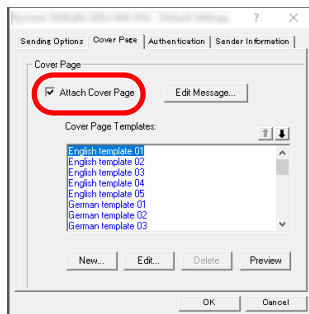

#### 3 Select the Cover Page to be attached.

Select a Cover Page template from the [Cover Page Templates] list.



#### NOTE

Original Cover Page templates can be created.

➔ [Creating New Cover Page Templates \(page 6-28\)](#)

## 4 Check the contents of the Cover Page.

- 1 Click on the **[Preview]** button. A preview of the currently selected template will be displayed.

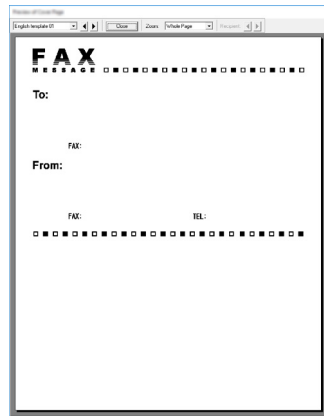

To display a different template, use the drop-down menu at the top of the dialog box or click on the **[◀]** or **[▶]** button. The template display magnification can also be changed within the range of 25 to 250% from the drop-down menu.

- 2 Click on the **[Close]** button.

## 5 Edit the Message.

- 1 Click on the **[Edit Message]** button.

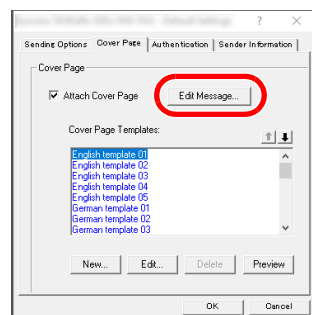

- 2 Enter the message to be added to the Cover Page and click on the **[OK]** button. A maximum of 1,000 characters can be entered.

## 6 Click on the **[OK]** button.

## Sender Information Registration

Please register the sender information to be included on the Cover Page.



### NOTE

For information regarding the registration method, refer to the following:

➔ [\(4\) Sender Information Tab \(page 6-14\)](#)

## Creating New Cover Page Templates

Perform the following procedure to create an original Cover Page template.

### 1 Open the Default Settings dialog box.

Perform the Default Settings Dialog Box procedure, open the **[Default Settings]** dialog box.

➔ [Default Settings Dialog Box \(page 6-11\)](#)

### 2 Edit the Cover Page templates.

1 Click on the **[Cover Page]** tab, place a check in the **[Attach Cover Page]** checkbox and click on the **[New...]** button.

The **[Edit Cover Page]** screen will be displayed.



- 2 Enter the characters.  
From the Menu bar, click on [Insert] and then [Textbox] and then position the textbox and enter the characters.

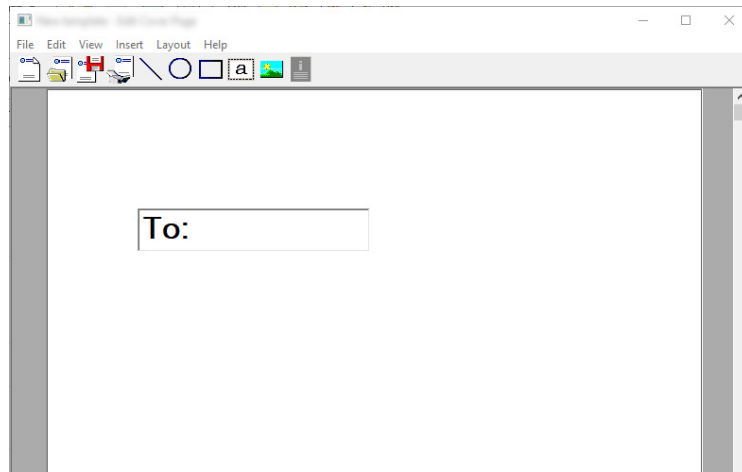

- 3 Position the field box.  
From the Menu bar's [Insert] menu, select the field box to be positioned.

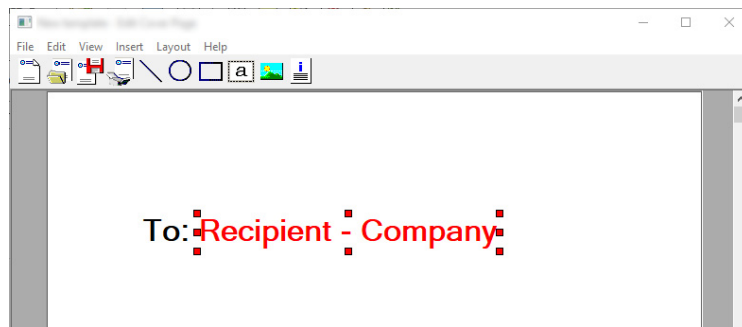

 **IMPORTANT**

If there are too many characters in the entered information, such as recipient name or company name, the information will not fit in the field box and some of the characters could be cut off. When positioning the field box, make it large enough and adjust the font point size so that the inserted information will fit in the field box.

 **NOTE**

When a fax is transmitted, the information entered in the Default Settings and Destination Settings will automatically be entered in the fields.

The following field boxes can be used. Use them as required.

Menu Item		Template Display	Inserted Information
Destination	Company	Recipient - Company	Recipient information company name
	Department	Recipient - Department	Recipient information department name
	Name	Recipient - Name	Recipient information recipient name
	Address	Recipient - Address	Recipient FAX number or Internet Fax Address
	All	Insert the four types of data above.	
Sender	Company	Sender - Company	Sender information company name
	Department	Sender - Department	Sender information department name
	Name	Sender - Name	Sender information sender name
	FAX Number	Sender - FAX Number	Sender information FAX number
	Telephone Number	Sender - Telephone Number	Sender information telephone number
	All	Insert the five types of data above.	
Comment		Comment	Message entered in the Cover Page tab

- 4 Position the figures, textboxes, etc., to create a Cover Page.



**NOTE**

For information regarding the operation method, refer to Help.

- 5 From the Menu bar click on **[File]** and then **[Save As]**, enter the file name, and click on the **[Save]** button.

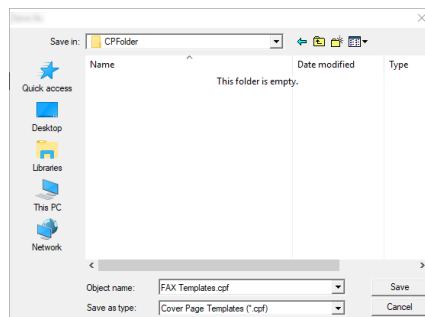

- 6 Close the **[Edit Cover Page]** screen.

- 7 The new template will be registered at the top of the list and can now be selected.

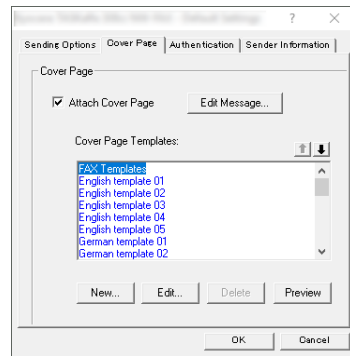

## Transmission Control

Perform the following procedure when you want to use your computer to verify the status of a fax transmission currently being processed, or to actually terminate that transmission.

Once a fax transmission starts being processed, a Transmission Control icon will be displayed in the Windows Task Bar.



- 1 Double-click on that icon to access the Transmission Control window which indicates the status of all transmissions being processed.

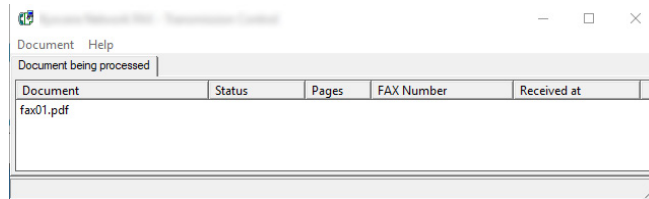

To terminate any transmission, select that transmission and then select [**Cancel**] from the **Document** menu.

### Ending Transmission Control

Right click on the Transmission Control icon and select [**Exit**].



# 7 Managing Jobs

This chapter explains the following topics:

Various Tools for Checking Transmission Results and Registration Status .....	7-2
Checking FAX Job History .....	7-3
Displaying Job Log Screen .....	7-3
Description of the Job Log Screen .....	7-4
Checking Details of the Job Log .....	7-5
Printing Administrative Reports (Result Report Setting) .....	7-7
Send Result Reports .....	7-7
Attach Image of NW FAX .....	7-8
Report for Job Canceled before Sending .....	7-8
Recipient Format .....	7-8
FAX RX Result Reports .....	7-9
Activity Report (Outgoing FAX Report and Incoming FAX Report) .....	7-10
Printing Activity Reports .....	7-10
Automatic Printout .....	7-10
Status Page .....	7-11
Reporting FAX Receipt Result by E-mail .....	7-12
Confirmation Screen of Destinations .....	7-13

## Various Tools for Checking Transmission Results and Registration Status

Check the fax transmission results and registration status using the following tools.

Tool	Display Location	Contents to Check	Timing of Check	Reference Page
FAX job history check	Touch panel	History of latest 100 send and receipt results stored	Any time	<a href="#">7-3</a>
Send result report / Receipt result report	Report printing	Latest send or receipt result	Automatic printout after every sending or receiving operation (No Print Output or Error Only is also optionally available.)	<a href="#">7-7</a>
Activity report	Report printing	Latest 50 send or receipt results	Any time, and automatic printout after every 50 sending/receiving	<a href="#">7-10</a>
Status page	Report printing	Registration status of Local FAX Number, Local FAX Name, fax line setting, etc.	Any time	<a href="#">7-11</a>
Reporting of FAX receipt result by Email	PC	Fax receipt	Fax reception is reported by e-mail.	<a href="#">7-12</a>

# Checking FAX Job History

Display the history of the latest 100 each of send and receipt results on the display for checking.

**NOTE**  
Even when job accounting is enabled, 100 each of send and receipt results are displayed regardless of the account ID.

For details of the job history check, refer to the following:

➔ *Machine's Operation Guide*

## Displaying Job Log Screen

### 1 Display the screen.

- 1 Select the [**Status/Job Cancel**] key.
- 2 Select [**Sending Jobs**] to check send result, [**Printing Jobs**] to check receipt result, and [**Storing Jobs**] to check the results of file storage in FAX Boxes and Polling box. Then select [**Log**].

### 2 Check

- 1 Select "Job Type" [⌵], and select "FAX" or "i-FAX".

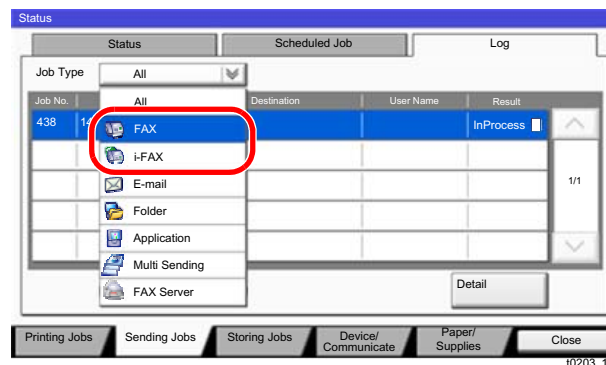



- 2 Select [**Close**] to exit.



## Description of the Job Log Screen

Items shown in each job log screen and the function of each key are as follows.

### Printing Job Log Screen



Display / Key	Description
Job No.	Job acceptance number
End Date	Job completed date
Type	Icon indicates job type.  Fax reception  i-FAX reception
Job Name	Job name
User Name	User name Blank if no information is available
Result	Result is indicated. Completed: Job ended properly. Canceled: Job was canceled. Error: Job ended improperly due to error.
"Job Type" [∨]	Specific type of job can be indicated (Fax or i-FAX reception in this screen).
[Detail]	Select a job from the list and select this key to show detailed information of the job.  <a href="#">Checking Details of the Job Log (page 7-5)</a>

### Sending Job Log Screen

Display / Key	Description
Job No.	Job acceptance number
End Date	Job completed date
Type	Icon indicates job type.  Fax transmission  i-FAX transmission
Destination	Recipient (destination name, fax number or i-FAX address)
User Name	User name Blank if no information is available
Result	Result is indicated. Completed: Job ended properly. Canceled: Job was canceled. Error: Job ended improperly due to error. Waiting: Although the received signal is not confirmed yet, a job is ended.
"Job Type" [∨]	Specific type of job can be indicated (Fax or i-FAX transmission in this screen).
[Detail]	Select a job from the list and select this key to show detailed information of the job.  <a href="#">Checking Details of the Job Log (page 7-5)</a>



## Storing Job Log Screen

Display / Key	Description
Job No.	Job acceptance number
End Date	Job completed date
Type	Icon indicates job type.  Storing fax reception data  Storing i-FAX reception data
Job Name	Job name
User Name	User name Blank if no information is available
Result	Result is indicated. Completed: Job ended properly. Canceled: Job was canceled. Error: Job ended improperly due to error.
"Job Type" [▽]	Specific type of job can be indicated.
[Detail]	Select a job from the list and select this key to show detailed information of the job. <a href="#">▶ Checking Details of the Job Log (page 7-5)</a>

### NOTE

Jobs stored in a Polling box appear as scanner () job types.

## Checking Details of the Job Log

You can check the detailed information of each job.

### Displaying Details of the Job Log

- 1 Select the [**Status/Job Cancel**] key.
- 2 [**Printing Jobs**], [**Sending Jobs**] or [**Storing Jobs**] > [**Log**]
- 3 Select the job to check > [**Detail**].  
Detailed information of the selected job is displayed.

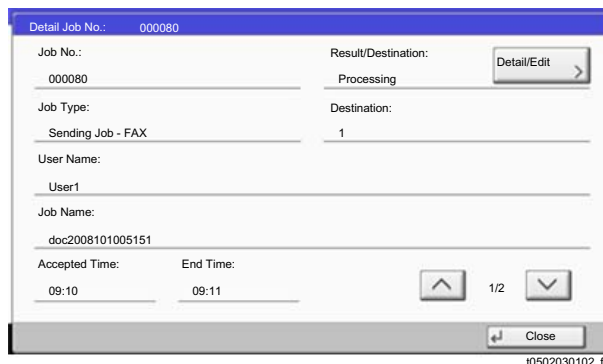

The screenshot shows a window titled "Detail Job No.: 000080". It contains the following fields and controls:

- Job No.: 000080
- Result/Destination: Processing (with a "Detail/Edit" button)
- Job Type: Sending Job - FAX
- Destination: 1
- User Name: User1
- Job Name: doc2008101005151
- Accepted Time: 09:10
- End Time: 09:11
- Navigation: Up arrow, 1/2, Down arrow
- Close button

### NOTE

Select [**^**] or [**∨**] to check information of the next or previous page.

- 4 Select [**Close**] to exit.

## Description of Detailed Information Screen

Item	Description
Job No.	Job acceptance number
Result (Result/ Destination)	Result is indicated. Completed: Job ended properly. Canceled: Job was canceled. Error: Job ended improperly due to error. Select [ <b>Detail</b> ] to check the result for each destination.
Job Type	Job type
Destination	The number of destinations is displayed.
User Name	User name Blank if no information is available
Job Name	Job name
Accepted Time	Time when job was accepted
End Time	Time when job ended
Original Pages	Number of pages in the original
Color/Black & White	Color mode used during scanning
Connected to	The Local FAX Name or Local FAX Number registered on the other party's machine (for fax reception and manual reception). i-FAX sender address (in the case of i-FAX reception) Blank if no information is available
Printed Pages	Number of printed pages

# Printing Administrative Reports (Result Report Setting)

You can print various administrative reports to check the results of fax transmission or the status of the functional setup.

## Send Result Reports

Each time you send a fax, you can print a report to confirm whether the fax was sent successfully. You can also print the transmitted image in the send result report.

### 1 Display the screen.

[System Menu/Counter] key > **[Report]** > "Result Report Setting" **[Next]** > "Send Result Report" **[Next]** > "FAX" **[Change]**

### 2 Configure the function.

- 1 Select **[Off]** (not to print), **[On]** (to print), **[Error Only]**, or **[Specify Each Job]**.



#### NOTE

When **[Specify Each Job]** is selected, it is possible to set a send result report when transmitting.

➔ [FAX TX Report \(page 3-30\)](#)

- 2 If you selected **[On]**, **[Error Only]** or **[Specify Each Job]**, specify whether the transmitted image is to be attached by selecting **[Off]** (do not print transmitted image), **[Partial Image]** (print part of the transmitted image at full size), or **[Full Image]** (print the entire transmitted image at reduced size).

#### With transmitted image

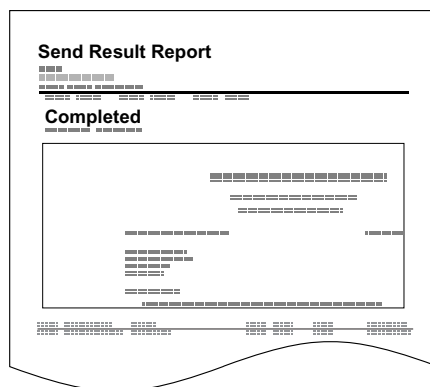

#### Without transmitted image

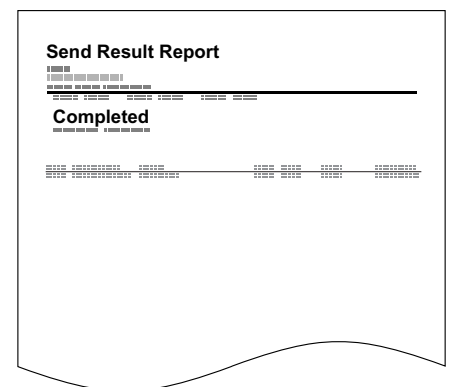

## Attach Image of NW FAX

Select whether the image to be attached to an Activity Report will be [Body] or [Cover Page], when using network fax.

### NOTE

For the [Send Result Report] > [FAX] > select [On], [Error Only] or [Specify Each Job] and the attachment of Send image is set at [Partial Image] or [Full Image], this setting is displayed.

➔ [Send Result Reports \(page 7-7\)](#)

### 1 Display the screen.

[System Menu/Counter] key > **[Report]** > "Result Report Setting" **[Next]** > "Send Result Report" **[Next]** > "Attach Image of NW FAX" **[Change]**

### 2 Configure the function.

[Body] or [Cover Page] > **[OK]**

## Report for Job Canceled before Sending

Print a send result report when the job is canceled before being sent.

### NOTE

This is not displayed if E-mail/Folder and Fax are both set to **[Off]** in Send Result Report.

### 1 Display the screen.

[System Menu/Counter] key > **[Report]** > "Result Report Setting" **[Next]** > "Send Result Report" **[Next]** > "Canceled before Sending" **[Change]**

### 2 Configure the function.

Select **[Off]** or **[On]**.

## Recipient Format

Select the Recipient Format for the send result report.

The name and destination that appear on the Send Result Report are taken from the information stored in the address book.

If **[Name or Destination]** is selected, either the name (destination name) or the destination (FAX No. or i-FAX address) stored in the address book is shown.

If **[Name and Destination]** is selected, both the name (destination name) and destination (FAX No. or i-FAX address) are shown.

When the destination was directly entered, only the destination (FAX No.) is shown.

### 1 Display the screen.

[System Menu/Counter] key > **[Report]** > "Result Report Setting" **[Next]** > "Send Result Report" **[Next]** > "Recipient Format" **[Change]**

### 2 Configure the function.

[Name or Destination] or [Name and Destination] > **[OK]**

## FAX RX Result Reports

Each time you receive a fax, you can print a report to confirm whether the fax was received successfully.



### NOTE

Fax receipt can also be notified by e-mail instead of checking the receipt result report.

➔ [Reporting FAX Receipt Result by E-mail \(page 7-12\)](#)

### 1 Display the screen.

[System Menu/Counter] key > [**Report**] > "Result Report Setting" [**Next**] > "FAX RX Result Report" [**Change**]

### 2 Configure the function.

Select [**Off**] (not to print), [**On**] (to print), or [**Error/Storing in Box**].

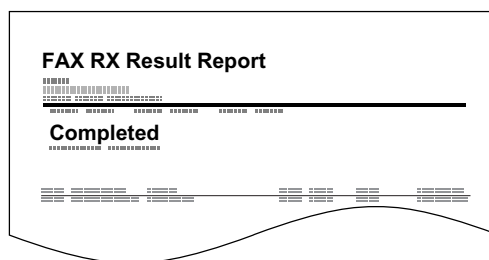

# Activity Report (Outgoing FAX Report and Incoming FAX Report)

Activity reports are reports of both the sent faxes and the received faxes. Each report lists the history of the latest 50 sent or received fax data. When automatic printout is selected, a report is printed out automatically after every 50 faxes sent or received.

## Printing Activity Reports

The latest 50 sent or received fax data are printed as a report.

### 1 Display the screen.

[Status/Job Cancel] key > [Device/Communicate] > [Log]

### 2 Print

1 Select [**Outgoing**] to print the sent fax report, and select [**Incoming**] to print the received fax report.

2 [**Print Report**] > [**Yes**]  
The report is printed.

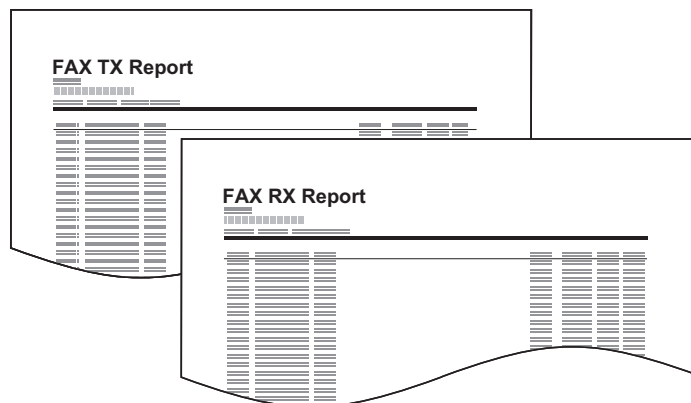

#### NOTE

You can select a shown fax job and select [**Detail**] to view detailed information of the job.

## Automatic Printout

An activity report is printed out automatically after every 50 faxes sent or received.

### 1 Display the screen.

[System Menu/Counter] key > [**Report**] > "Admin Report Settings" [**Next**] > "Outgoing FAX Report" or "Incoming FAX Report" [**Change**]

### 2 Configure the function.

[**Off**] (not to print) or [**On**] (to print) > [**OK**]

# Status Page

A status page provides information on a number of user setups. FAX-related information includes the Local FAX Number, Local FAX Name, fax line setting, etc. You can print it out as necessary.

## 1 Display the screen.

[System Menu/Counter] key > **[Report]** > "Print Report" **[Next]**

## 2 Print

"Status Page" **[Print]** > **[Yes]**

A status page is printed.

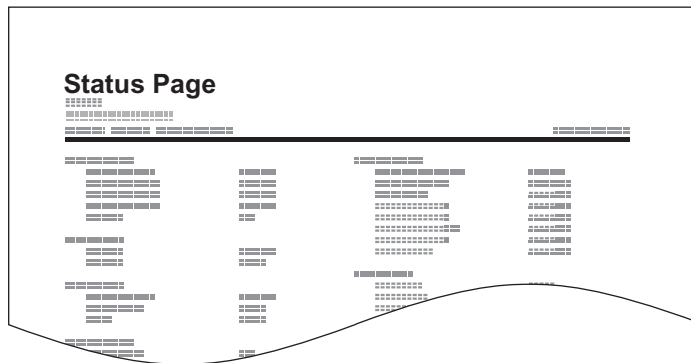

# Reporting FAX Receipt Result by E-mail

Fax receipt can also be notified by e-mail instead of checking the receipt result report.

```
Job No.: 000019
Result: OK
End Time: Sun 24Oct2010 14:53:38
File Name: doc23042006145300

Result Job Type Address
-----
OK FAX 123456

-----
XX-XXXX
[00:c0:ee:1a:01:24]
-----
```



## NOTE

This setting is displayed when the FAX RX Result Report setting is **[On]** or **[Error/Storing in Box]**.

➔ [FAX RX Result Reports \(page 7-9\)](#)

If the setting is **[Error/Storing in Box]**, E-mail notification is provided when an error occurs or a received fax is forwarded to FAX Box.

## 1 Display the screen.

[System Menu/Counter] key > **[Report]** > "Result Report Setting" **[Next]** > "RX Result Report Type" **[Change]**

## 2 Select the destination.

**Select from the address book**

1 **[E-mail Address Book]** > **[Address Book]**

2 Select the destination from the Address Book and select **[OK]**.



## NOTE

For the procedure of selecting destinations from the Address Book, refer to following:

➔ [Choosing from the Address Book \(page 3-9\)](#)

**Enter the E-mail address**

1 **[E-mail Address Entry]** > **[E-mail Address]**

2 Enter the address of the destination and select **[OK]**.

For details on character entry, refer to the following:

➔ [Character Entry Method \(page 12-2\)](#)



# Confirmation Screen of Destinations

When selecting [**On**] for Dest. Check before Send, the confirmation screen of destinations appears after pressing the [**Start**] key.

➔ Machine's *Operation Guide*

Follow the steps below to confirm the destinations.

## 1 Check all destinations.

Select [^] or [v] to confirm every destination. Select [**Detail**] to display the detailed information on the selected destination.



### NOTE

Be sure to confirm every destination by displaying them on the touch panel. You cannot select [**Check**] unless you have confirmed every destination.

## 2 Change a destination.

### Delete a destination

1 To delete the destination, select the destination you want to delete.

2 [**Delete**] > [**Yes**]  
The destination is deleted.

### Add a destination

To add the destination, select [**Cancel**] and then return to the destination screen.

## 3 Select [**Check**].

When you have finished checking all destinations, select [**Check**].

## 4 Press the [**Start**] key.

Start sending.

# 8 Fax Settings

This chapter explains the following topics:

Default fax settings .....	8-2
Operation method .....	8-2
System Menu Settings .....	8-4
Cassette/MP Tray Settings .....	8-5
Common Settings .....	8-6
Document Box/USB Drive .....	8-9
FAX .....	8-9
Report .....	8-15
Adjustment/Maintenance .....	8-15
Transmission Restriction .....	8-16
Registering Permit FAX No. ....	8-17
Changing Permit FAX No. ....	8-18
Deleting Permit FAX No. ....	8-18
Registering Reject FAX No. ....	8-19
Changing Reject FAX No. ....	8-19
Deleting Reject FAX No. ....	8-20
Registering Permit ID No. ....	8-20
Changing Permit ID No. ....	8-21
Deleting Permit ID No. ....	8-21
Setting Send Restriction .....	8-22
Setting Reception Restriction .....	8-22
Unknown Number Reception .....	8-23
Unusable Time .....	8-24
Account Management .....	8-26

# Default fax settings

This section explains the fax settings in the system menu.

## Operation method

- 1 Display the screen.**  
Select the [System Menu/Counter] key.
- 2 Select a function.**

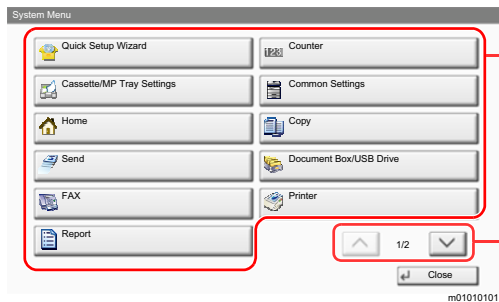

- 1 Displays the System Menu items.
- 2 Scrolls up and down when the list of values cannot be displayed in its entirety on a single screen.
- 3 Displays setting items  
Select the key of a function to display the setting screen.
- 4 Returns to the previous screen.

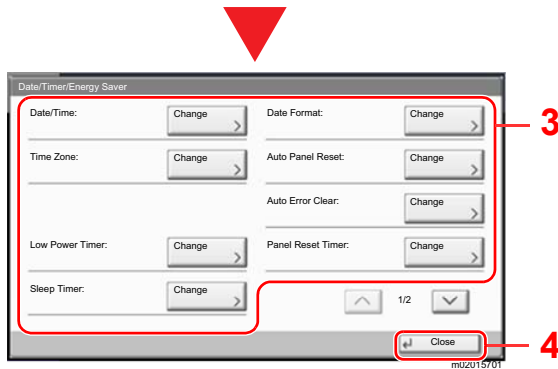

- 3 Configure the function.**

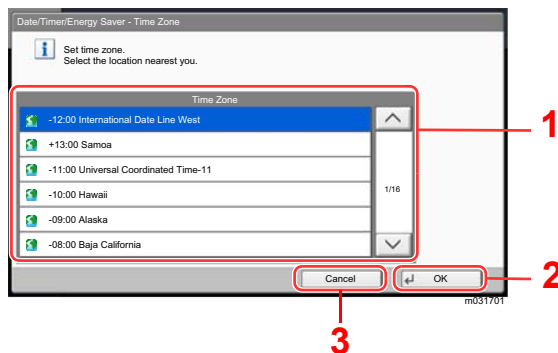

- 1 Enter a setting by selecting it.
- 2 Accepts the settings and exits.
- 3 Returns to the previous screen without making any changes.

**NOTE**

If user login administration is enabled, you can only change the settings by logging in with administrator privileges or as a user with privileges to configure this setting.

The factory default login user name and login password are set as shown below.

Model Name	Login User Name	Login Password
TASKalfa 2553ci	2500	2500
TASKalfa 3253ci	3200	3200
TASKalfa 3553ci	3500	3500
TASKalfa 4053ci	4000	4000
TASKalfa 5003i/TASKalfa 5053ci	5000	5000
TASKalfa 6003i/TASKalfa 6053ci	6000	6000
TASKalfa 7003i	7000	7000
TASKalfa 7353ci	7300	7300
TASKalfa 8003i	8000	8000
TASKalfa 8353ci	8300	8300
TASKalfa 9003i	9000	9000

If function default settings have been changed, the **[Reset]** key can be selected in each function screen to immediately change the settings.

Refer to System Menu Settings on the following page and configure as needed.

## System Menu Settings

Settings for the fax function in the system menu are shown below.



### NOTE

For settings other than fax settings, refer to the following:

➔ *Machine's Operation Guide*

Item	Description	Reference Page
<b>Quick Setup Wizard</b>	Configures settings for the machine in a wizard format.	—
<b>FAX Setup</b>	Configures fax settings in a wizard format.	2-12
<b>Power Off Setup</b>	Set the mode whether display a confirmation message in power supply off.	2-13
<b>Cassette/MP Tray Settings</b>	Select paper size and media type for Cassette 1 to 4 and multipurpose tray.	8-5
<b>Common Settings</b>	Configures overall machine operation.	8-6
<b>Document Box/USB Drive</b>	Configures settings related to the FAX Box, Polling Box and FAX Memory RX Box. For details on FAX Box, refer to the following: ➔ <a href="#">FAX Box Function (page 5-17)</a> For details on Polling Box, refer to the following: ➔ <a href="#">Polling Communication (page 5-28)</a> For details on FAX Memory RX Box, refer to the following: ➔ <a href="#">FAX Memory RX Box (page 5-35)</a>	8-9
<b>FAX</b>	Configures settings for fax functions.	8-9
<b>Report</b>	Print reports to check the machine settings and status, or set various reports for checking the results of sending and receiving.	8-15
<b>Edit Destination</b>	Configures Address Book and One Touch Key settings. For details on Address Book, refer to the following: ➔ <a href="#">Adding a Destination (Address Book) (page 2-16)</a> For details on One Touch Key, refer to the following: ➔ <a href="#">Adding a Destination on One Touch Key (page 2-25)</a>	—
<b>Date/Timer/Energy Saver</b>	Set the date and time for the location where you use the machine. For details, refer to the following: ➔ <a href="#">Setting Date and Time (page 2-15)</a> This feature sets a time period during which the machine will not print received faxes. For details, refer to the following: ➔ <a href="#">Unusable Time (page 8-24)</a>	—
<b>Adjustment/Maintenance</b>	Adjust printing quality and conduct machine maintenance.	8-15

## Cassette/MP Tray Settings

Select paper size and media type for Cassettes.

### Cassette1 (to 5)

(When using TASKalfa 6053ci/TASKalfa 5053ci/TASKalfa 4053ci/TASKalfa 3553ci/  
TASKalfa 3253ci/TASKalfa 2553ci/TASKalfa 6003i/TASKalfa 5003i.)

[System Menu/Counter] key > [Cassette/MP Tray Settings] > [Cassette1 (to 5)]

Item	Description
<b>Paper Size</b> <sup>*3</sup>	Set the paper size to load in Cassette 1 (to Cassette 5) <sup>*1</sup> . <input checked="" type="radio"/> <b>IMPORTANT:</b> Specify the settings as follows for the cassette that you want to use for fax reception. Inch models: [Auto] > [Inch] Metric models: [Auto] > [Metric]
<b>Media Type</b>	Set the media type to load in Cassette 1 (to Cassette 5) <sup>*1</sup> . <b>Value:</b> Plain, Rough, Vellum, Recycled, Preprinted <sup>*2</sup> , Bond, Cardstock <sup>*3</sup> , Color, Prepunched <sup>*2</sup> , Letterhead <sup>*2</sup> , Envelope <sup>*3</sup> , Thick, High Quality or Custom 1-8

\*1 The cassette tray displayed varies depending on the installation status of the optional paper feeder.

\*2 Cannot be used to receive faxes. If set to FAX Exclusive Paper Source, it will not be displayed.

\*3 Cannot be set for the optional Large Capacity Feeder (1,500-sheet × 2) or Side Feeder (3,000-sheet × 1).

### Cassette1 (to 7) (When using TASKalfa 8353ci/TASKalfa 7353ci/TASKalfa 9003i/ TASKalfa 8003i/TASKalfa 7003i.)

[System Menu/Counter] key > [Cassette/MP Tray Settings] > [Cassette1 (to 7)]

Item	Description
<b>Paper Size</b> <sup>*3</sup>	Set the paper size to load in Cassette 1 (to Cassette 7) <sup>*1</sup> . <input checked="" type="radio"/> <b>IMPORTANT:</b> Specify the settings as follows for the cassette that you want to use for fax reception. Inch models: [Auto] > [Inch] Metric models: [Auto] > [Metric]
<b>Media Type</b>	Set the media type to load in Cassette 1 (to Cassette 7) <sup>*1</sup> . <b>Value:</b> Plain, Rough, Vellum, Recycled, Preprinted <sup>*2</sup> , Bond, Cardstock <sup>*3</sup> , Color, Prepunched <sup>*2</sup> , Letterhead <sup>*2</sup> , Envelope <sup>*3</sup> , Thick, Coated <sup>*4</sup> , High Quality or Custom 1-8

\*1 The cassette tray displayed varies depending on the installation status of the optional paper feeder.

\*2 Cannot be used to receive faxes. If set to FAX Exclusive Paper Source, it will not be displayed.

\*3 Cannot be set for the optional Large Capacity Feeder (1,500-sheet × 2) or Side Feeder (3,000-sheet × 1).

\*4 Can be set for Cassette 5 when using the optional Side Feeder (500-sheet × 3) or Large Capacity Side Feeder (500-sheet, 1,500-sheet × 2).

## MP Tray Setting

[System Menu/Counter] key > [Cassette/MP Tray Settings] > [MP Tray Setting]

Item	Description
<b>Paper Size</b>	<p>Set the paper size for multipurpose tray.</p> <p><input checked="" type="checkbox"/> <b>IMPORTANT:</b> Specify the settings as follows for the cassette that you want to use for fax reception.</p> <p>Inch models: [Auto] &gt; [Inch]</p> <p>Metric models: [Auto] &gt; [Metric]</p>
<b>Media Type</b>	<p>Set the media type for multipurpose tray.</p> <p><b>Value:</b> Plain, Transparency<sup>*1</sup>, Rough, Vellum, Labels, Recycled, Preprinted<sup>*1</sup>, Bond, Cardstock, Color, Prepunched<sup>*1</sup>, Letterhead<sup>*1</sup>, Envelope, Thick, Coated, High Quality, Index Tab Dividers<sup>*1</sup>, Custom 1-8</p>

\*1 Cannot be used to print received faxes.

## Common Settings

Configures overall machine operation.

### Sound

[System Menu/Counter] key > [Common Settings] > [Sound]

Item	Description
<b>Buzzer</b>	Set options for buzzer sound during the machine operations.
<b>Job Finish</b>	<p>Emit a sound when a job is normally completed.</p> <p><b>Value:</b> Off, On, FAX Reception Only</p>
<b>FAX Speaker Volume</b>	<p>Adjust the volume of the speaker.</p> <p>Speaker Volume: Volume of the built-in speaker when the line is connected by selecting On Hook key.</p> <p><b>Value:</b> [1] (Minimum), [2], [3] (Medium), [4], [5] (Maximum), [0] (Mute)</p>
<b>FAX Monitor Volume</b>	<p>Adjust the volume of the monitor.</p> <p>Monitor Volume: Volume of the built-in speaker when the line is connected without selecting On Hook key such as in memory transmission.</p> <p><b>Value:</b> [1] (Minimum), [2], [3] (Medium), [4], [5] (Maximum), [0] (Mute)</p>

## Paper Output

[System Menu/Counter] key > [Common Settings] > [Paper Output]

When using TASKalfa 6053ci/TASKalfa 5053ci/TASKalfa 4053ci/TASKalfa 3553ci/TASKalfa 3253ci/TASKalfa 2553ci/TASKalfa 6003i/TASKalfa 5003i.

Item	Description
FAX Port 1	Set the output tray for printing of receiving faxes.* <sup>1</sup>
FAX Port 2* <sup>2</sup>	<p><b>Value:</b></p> <p>with optional job separator</p> <ul style="list-style-type: none"> <li>• Inner Tray: Outputs to the Inner Tray of the machine.</li> <li>• Job Separator Tray: Outputs to the Job Separator.</li> </ul> <p>with optional 1,000-Sheet Finisher</p> <ul style="list-style-type: none"> <li>• Job Separator Tray: Outputs to the Job Separator.</li> <li>• Finisher Tray: Outputs to the Finisher Tray of the optional Document Finisher.</li> </ul> <p>with optional 4,000-sheet Finisher/100-sheet Staple Finisher</p> <ul style="list-style-type: none"> <li>• Job Separator Tray: Outputs to the Job Separator.</li> <li>• Tray A: Delivery to the Tray A of the optional Document Finisher.</li> <li>• Tray B: Delivery to the Tray B of the optional Document Finisher.</li> </ul> <p>with optional Mailbox</p> <ul style="list-style-type: none"> <li>• Job Separator Tray: Outputs to the Job Separator.</li> <li>• Tray A: Delivery to the Tray A of the optional Document Finisher.</li> <li>• Tray B: Delivery to the Tray B of the optional Document Finisher.</li> <li>• Tray 1 to 7: Delivery to tray 1 to 7 (tray 1 is the uppermost tray) of the optional Mailbox.</li> </ul>

\*1 When an Inner Finisher is installed with the machine, this function is not displayed.

\*2 This function is displayed when 2 optional FAX Kits (Dual FAX option) are installed.

When using TASKalfa 8353ci/TASKalfa 7353ci/TASKalfa 9003i/TASKalfa 8003i/TASKalfa 7003i.

Item	Description
FAX Port 1	Set the output tray for printing of receiving faxes.
FAX Port 2* <sup>1</sup>	<p><b>Value:</b></p> <ul style="list-style-type: none"> <li>• Upper Left Tray: Outputs to the Upper Left Tray.</li> <li>• Lower Left Tray: Outputs to the Lower Left Tray.</li> <li>• Right Tray: Outputs to the Right Tray of the machine.</li> </ul> <p>with optional 4,000-Sheet Finisher/100-sheet Staple Finisher</p> <ul style="list-style-type: none"> <li>• Right Tray: Outputs to the Right Tray of the machine.</li> <li>• Tray A: Delivery to the Tray A of the optional Document Finisher</li> <li>• Tray B: Delivery to the Tray B of the optional Document Finisher</li> </ul> <p>with optional Mailbox</p> <ul style="list-style-type: none"> <li>• Right Tray: Outputs to the Right Tray of the machine.</li> <li>• Tray A: Delivery to the Tray A of the optional Document Finisher</li> <li>• Tray B: Delivery to the Tray B of the optional Document Finisher</li> <li>• Tray 1 to 7: Delivery to tray 1 to 7 (tray 1 is the uppermost tray) of the optional Mailbox</li> </ul>

\*1 This function is displayed when 2 optional FAX Kits (Dual FAX option) are installed.



## Function Defaults

[System Menu/Counter] key > [Common Settings] > [Function Defaults]

Item	Description
<b>FAX TX Resolution</b>	Select the default scanning resolution. <b>Value:</b> 600x600dpi, 400x400dpi Ultra Fine, 200x400dpi Super Fine, 200x200dpi Fine, 200x100dpi Normal
<b>i-FAX Subject/Body<sup>*1</sup></b>	Set the subject and body automatically entered (default subject and body) when sending the scanned originals by i-FAX. <b>Value:</b> Subject: Up to 60 characters can be entered. Body: Up to 500 characters can be entered.
<b>Continuous Scan (FAX)</b>	Set the continuous scan defaults. <b>Value:</b> Off, On

\*1 This function is displayed when the optional Internet FAX Kit is installed.

## Display Status/Log

[System Menu/Counter] key > [Common Settings] > [Display Status/Log]

Item	Description
<b>Display FAX Log</b>	Set the display method of the Status/Log. <b>Value:</b> Show All, Hide All

## Function Key Assignment

[System Menu/Counter] key > [Common Settings] > [Function Key Assignment]

Item	Description
<b>Function Key 1</b>	Assign a function to each function key.
<b>Function Key 2</b>	<b>Value:</b> None, Copy, Send, FAX Server, FAX, Custom Box, Job Box, USB Drive, FAX Box, FAX Memory RX Box, Send to Me (E-mail), Send to Me from Box (E-mail), Internet Browser, ID Card Copy, Program <sup>*1</sup> , Application <sup>*2</sup>
<b>Function Key 3</b>	
	 <b>NOTE</b> You can select the functions to be displayed for [All], [Application], [Program] and [Others].

\*1 The registered program will be displayed.

\*2 The running application will be displayed.

## Show Power Off Message

[System Menu/Counter] key > [Common Settings] > [Show Power Off Message]

Item	Description
<b>Show Power Off Message</b>	Set the mode whether display a confirmation message in power supply off. <b>Value:</b> Off, On

## Document Box/USB Drive

Configures settings for the FAX Memory RX Box.

### FAX Memory RX Box

[System Menu/Counter] key > [Document Box/USB Drive] > [FAX Memory RX Box]

Item	Description
FAX Memory RX	Configure whether to save the received faxes one into the FAX Memory RX Box. Value: Off, On

## FAX

Settings related to the fax function can be configured.



### TX/RX Common



[System Menu/Counter] key > [FAX] > [TX/RX Common]

Item	Description
Encryption Key Registration	This is used to register an encryption key for encrypted communication. ➔ <a href="#">The fax will be deleted. (page 5-36)</a>
FAX Remote Diagnosis	If a problem arises with this machine and you contact our service representative, this feature enables our Service Center computer to access the machine over the phone and check the machine's status or look for problems.  <b>NOTE:</b> To use Remote Diagnostics, you must first sign an agreement with our service representative and register a Predetermined ID on the machine. For more information, contact your Service Representative or Authorized Service Center. Value: On, Off
Remote Diagnostics ID	If you have turned on Remote Diagnostics, enter the predetermined ID. Value: 0000 - 9999

## Transmission

[System Menu/Counter] key > [FAX] > [Transmission]



Item		Description
Basic	Local FAX Name (Port 1)	Local FAX Name Entry
	Local FAX Name (Port 2) <sup>*1</sup>	Local FAX Name Entry
	TTI	
	Account as Local FAX Name	
	Retry Times	
		<p>Register the local FAX name printed in the transmit terminal identification (TTI) area.</p> <p> <b>NOTE:</b> If two fax kits are installed and two telephone lines are used, TTI information can be registered for each line. Settings specified in Local FAX Name Entry (Port 1) are applied to Internet fax.</p> <p>This item is included in the Quick Setup Wizard.</p> <p>➔ <a href="#">Quick Setup Wizard (page 2-12)</a></p>
		<p>The transmit terminal identification (TTI) is the information about the sending machine (transmit terminal) that is printed by the receiving machine on the received fax. The information includes the date and time of transmission, number of pages sent, name and fax number. This machine enables the user to select if the TTI is printed out on the fax on the receiving system. Regarding the location of the information to be printed, you can select inside or outside of the page image being sent.</p> <p><b>Value:</b> Off, Outside, Inside</p> <p> <b>NOTE:</b> Normally, the Local FAX Name is printed in the transmit terminal identification (TTI). However, when job accounting is enabled and an Account ID is entered when a fax is sent, you can enable a setting to have the Account Name or Local FAX Name, whichever was selected, be printed.</p> <p>This item is included in the Quick Setup Wizard.</p> <p>➔ <a href="#">Quick Setup Wizard (page 2-12)</a></p>
		<p>Select whether or not to use account name as local FAX name.</p> <p><b>Value:</b> Off, On</p>
		<p>The number of retry times can be changed.</p> <p>This item is included in the Quick Setup Wizard.</p> <p>➔ <a href="#">Quick Setup Wizard (page 2-12)</a></p>

Item		Description
FAX	Local FAX Number 1	Register the local FAX number printed in the transmit terminal identification (TTI) area.
	Local FAX Number 2 <sup>*1</sup>	If you have already registered a number, the current registered number is displayed. This item is included in the Quick Setup Wizard. ➔ <a href="#">Quick Setup Wizard (page 2-12)</a>
	Dialing Mode (Port 1) (Inch version only)	Select the telephone line according to the type you are contracted with. Please note that selecting a wrong telephone line will prevent you from sending fax.
	Dialing Mode (Port 2) <sup>*1</sup> (Inch version only)	<b>Value:</b> Tone(DTMF), Pulse(10PPS) This item is included in the Quick Setup Wizard. ➔ <a href="#">Quick Setup Wizard (page 2-12)</a>
	Local FAX ID	Register the local FAX ID. This item is included in the Quick Setup Wizard. ➔ <a href="#">Quick Setup Wizard (page 2-12)</a>  <b>NOTE:</b> The Local FAX ID is used for transmission limit purposes. ➔ <a href="#">Transmission Restriction (page 8-16)</a>
	ECM TX (Port1)	Set whether ECM TX is performed.
	ECM TX (Port2) <sup>*1</sup>	ECM is a communication mode specified by the ITU-T (International Telecommunication Union) that retransmits data when an error occurs. Fax machines that have ECM mode check for errors as they communicate, preventing distortion of the image due to noise on the line and other conditions. <b>Value:</b> On, Off  <b>NOTE</b> When there is a large amount of noise on the line, communication may take slightly longer than when [Off] is selected.
	TX Start Speed (Port1)	Set the TX Start Speed.
	TX Start Speed (Port2) <sup>*1</sup>	When communication conditions are bad, the fax may not be transmitted correctly. In that case, set a lower TX Start Speed. <b>Value:</b> 9600bps, 14400bps, 33600bps  <b>NOTE</b> Normally this should be used with the default setting.
Always Cont Scan w/Platen	When scanning faxes on the platen, turn on Continuous Scan. <b>Value:</b> On, Off	





\*1 This function is displayed when 2 optional FAX Kits (Dual FAX option) are installed.

## Reception

[System Menu/Counter] key > [FAX] > [Reception]

Item		Description
Basic	Media Type	<p>Specify the paper type to be used for print output of the received fax.  <b>Value:</b> All Media Types, Plain, Rough, Vellum, Labels, Recycled, Bond, Cardstock, Color, Envelope, Thick, Coated, High Quality, Custom 1-8</p> <p>➔ <a href="#">Media Type for Print Output (page 4-6)</a></p> <p> <b>NOTE</b>            If FAX exclusive paper source is set, paper is fed from the cassette set as the FAX exclusive paper source.</p> <p>➔ <a href="#">FAX Exclusive Paper Source (page 8-12)</a></p>
	FAX Exclusive Paper Source	<p>Set fax exclusive paper cassettes.            Cannot select the cassettes below.</p> <ul style="list-style-type: none"> <li>• Paper Size is set to other than Auto.</li> <li>• Media Type is set to Preprinted, Prepunched, Letterhead.</li> </ul> <p><b>Value:</b> Cassette 1 to 7*<sup>1</sup></p> <p>➔ <a href="#">FAX Exclusive Paper Source (page 4-7)</a></p> <p> <b>NOTE</b>            For FAX related reports, paper is fed from the cassette set as the FAX exclusive paper source.</p>
	Multipurpose Tray	<p>You can select whether to use the MP tray paper when printing out the received fax.</p> <p><b>Value:</b> Off, On</p> <p>➔ <a href="#">Multipurpose Tray (page 4-7)</a></p>
	Reduced RX Size	<p>When the reception size is larger than the paper size, you can reduce the print size.</p> <p><b>Value:</b> Off, On</p> <p>➔ <a href="#">Reduced RX Size (page 4-7)</a></p>
	Reception Date/Time	<p>Reception Date/Time function adds the reception date/time, sender information and number of pages on the top of each page when the received fax is printed out. It is useful for confirming the time of reception if the fax is from a different time zone.</p> <p><b>Value:</b> Off, On</p> <p>➔ <a href="#">Reception Date/Time (page 4-8)</a></p>
	Duplex Printing	<p>When received multiple pages of data are the same width, they can be printed out on both sides of paper having the same width as the data.</p> <p><b>Value:</b> Off, On</p> <p>➔ <a href="#">Duplex Printing (page 4-8)</a></p>
	2 in 1 Printing	<p>When you receive a multi-page Statement or A5 size original, this function prints 2 pages of the original at a time on one Letter or A4 size sheet of paper.</p> <p><b>Value:</b> Off, On</p> <p>➔ <a href="#">2 in 1 Print (page 4-8)</a></p>

\*1 The cassette tray displayed varies depending on the installation status of the optional paper feeder.

Item	Description
<b>FAX</b> <b>Rings(Normal)</b>	<p>If the reception method is fax automatic reception, the number of rings until the machine answers a call can be changed as needed.</p> <p> <b>NOTE</b> This setting does not appear in some regions.</p>
<b>Rings (TAD)</b>	<p>If the reception method is FAX/Answering Machine Auto Switch Reception, the number of rings until the machine answers a call can be changed as needed.</p> <p> <b>NOTE</b> This setting does not appear in some regions.</p>
<b>Rings(FAX/TEL)</b>	<p>If the reception method is FAX/TEL Auto Switch Reception, the number of rings until the machine answers a call can be changed as needed.</p> <p> <b>NOTE</b> This setting does not appear in some regions.</p>
<b>RX Setting</b>	<p>Select the reception mode.  <b>Value:</b> Auto (Normal), Auto (FAX/TEL), Auto (TAD), Manual, Auto (DRD)            If Auto (DRD) is selected, select the DRD Pattern.  <b>Value:</b> Pattern 1 (Normal Ring), Pattern 2 (Double Ring), Pattern 3 (Short-Short-Long), Pattern 4 (Short-Long-Short)            DRD reception mode is available for some countries.</p> <p>➔ <a href="#">FAX Reception (page 4-2)</a>  <a href="#">Manual Reception (page 4-4)</a>  <a href="#">DRD Reception (Available for some countries.) (page 5-45)</a></p>
<b>Remote SW Dial</b>	<p>To start fax reception by operation from the connected telephone set, use the following operation.  <b>Value:</b> 00 - 99</p> <p>➔ <a href="#">Remote Switch Function (page 5-49)</a></p>
<b>Reception Port<sup>*1</sup></b>	<p>You can make one of the 2 phone lines a receive-only line.  <b>Value:</b> Off, Port 1, Port 2</p> <p>➔ <a href="#">Reception Port Selection (page 9-3)</a></p>
<b>ECM RX (Port1)</b>	<p>Set whether ECM RX is performed.            ECM is a communication mode specified by the ITU-T (International Telecommunication Union) that retransmits data when an error occurs. Fax machines that have ECM mode check for errors as they communicate, preventing distortion of the image due to noise on the line and other conditions.  <b>Value:</b> On, Off</p> <p> <b>NOTE</b> When there is a large amount of noise on the line, communication may take slightly longer than when <b>[Off]</b> is selected.</p>
<b>ECM RX (Port2)<sup>*1</sup></b>	
<b>RX Start Speed (Port1)</b>	<p>Change the RX Start Speed.            When communication conditions are bad, the fax may not be received correctly. In that case, set a lower RX Start Speed.  <b>Value:</b> 9600bps, 14400bps, 33600bps</p> <p> <b>NOTE</b> Normally this should be used with the default setting.</p>
<b>RX Start Speed (Port2)<sup>*1</sup></b>	

Item	Description
<b>Encrypted Reception</b>	Turns on reception by encrypted communication. Value: Off, On If turned on, select the encryption key. ➔ <a href="#">The fax will be deleted. (page 5-36)</a>

\*1 This function is displayed when 2 optional FAX Kits (Dual FAX option) are installed.

## TX/RX Restriction

[System Menu/Counter] key > [FAX] > [TX/RX Restriction]

This function allows you to send or receive originals only when communication requirements are met.

➔ [Transmission Restriction \(page 8-16\)](#)

## RX/Forward Rules

[System Menu/Counter] key > [FAX] > [RX/Forward Rules]

When you have received a fax, you can forward the received image to other faxes and computers or specify a number of copies.

➔ [Memory Forwarding \(page 5-2\)](#)

## New Destination Entry(FAX)

[System Menu/Counter] key > [FAX] > [New Destination Entry(FAX)]

Item	Description
<b>New Destination Entry(FAX)<sup>*1</sup></b>	Select whether to permit direct entry of destination. When this option is set to [Prohibit], you cannot enter the destination directly. Value: Permit, Prohibit

\*1 If [Prohibit] is set for new destination entry in [Send] in system menu, this option is grayed out and this option cannot be set.

## Quick Setup Registration

[System Menu/Counter] key > [FAX] > [Quick Setup Registration]

Item	Description
<b>Quick Setup Registration</b>	Select the functions to be registered for Quick Setup. Six keys of the Quick Setup screen are allocated to typical functions but can be changed as necessary. Six items in the following options are available. Value: Original Size, 2-sided/Book Original <sup>*1</sup> , Sending Size, Original Orientation, Density, Original Image, FAX TX Resolution, Zoom, Continuous Scan

\*1 Use "Book original" if the document processor is optional and the document processor is not installed.

## Report

Print reports to check the machine settings and status, or set various reports for checking the results of sending and receiving.

### Report Print

[System Menu/Counter] key > [Report] > [Print Report]

Item	Description
<b>Status Page</b>	<p>A status page provides the current status of machine. FAX-related information includes the Local FAX Number, Local FAX Name, fax line setting, etc. You can print it out as necessary.</p> <p>➔ <a href="#">Status Page (page 7-11)</a></p>

### Admin Report Settings

[System Menu/Counter] key > [Report] > [Admin Report Settings]

Item	Description
<b>Outgoing FAX Report</b>	<p>An activity report is printed out automatically after every 50 faxes sent.</p> <p>➔ <a href="#">Activity Report (Outgoing FAX Report and Incoming FAX Report) (page 7-10)</a></p>
<b>Incoming FAX Report</b>	<p>An activity report is printed out automatically after every 50 faxes received.</p> <p>➔ <a href="#">Activity Report (Outgoing FAX Report and Incoming FAX Report) (page 7-10)</a></p>

### Result Report Setting

[System Menu/Counter] key > [Report] > [Result Report Setting]

Item	Description
<b>Send Result Report</b>	<p>Each time you send a fax, you can print a report to confirm whether the fax was sent successfully.</p> <p>➔ <a href="#">Send Result Reports (page 7-7)</a></p>
<b>FAX RX Result Report</b>	<p>When a fax is received, you can be notified by receipt result report.</p> <p>➔ <a href="#">FAX RX Result Reports (page 7-9)</a></p>
<b>Job Finish Notice Setting</b>	<p>Attaches sent images to job finish notices.</p> <p>Value: Do Not Attach Image, Attach Image</p>
<b>RX Result Report Type</b>	<p>Fax receipt can also be notified by e-mail instead of checking the receipt result report.</p> <p>➔ <a href="#">Reporting FAX Receipt Result by E-mail (page 7-12)</a></p>

## Adjustment/Maintenance

[System Menu/Counter] key > [Adjustment/Maintenance]

Adjust printing quality and conduct machine maintenance.

Item	Description
<b>Density Adjustment</b>	Adjust density.
<b>FAX</b>	<p>Adjust the FAX scan density to darker or lighter. Adjustment can be made in 7 levels.</p> <p>Value: -3 (Lighter), -2, -1, 0 (Normal), +1, +2, +3 (Darker)</p>



# Transmission Restriction

This function allows you to send or receive originals only when communication requirements are met. Using this function can limit other parties with which you can communicate.

Specifically, you must register communication requirements (Permit FAX No./Permit ID No.) and set the transmission limit in advance. When the machine sends or receives originals, you do not need to perform a special operation for this particular function, and you can operate the machine normally. When sending or receiving has actually started, the machine correctly conducts transmission that meets communication requirements, but when the transmission does not meet the requirements, the machine indicates an error. This mode also allows you to set a **[Reject List]** for Reception Restriction so that reception from senders on the list of Rejected FAX numbers or from senders whose Local FAX Number is not registered are rejected. (You can select whether reception from a party whose local fax number is not registered is allowed or rejected in "Unknown Number Reception".)

➔ [Unknown Number Reception \(page 8-23\)](#)



## NOTE

Before using transmission restriction, be sure to read the following prerequisites, communication establishing requirements, and reception rejection requirements thoroughly, and consult with the other parties with which you communicate.

	Prerequisites	Communication Establishing Requirements
Send Restrictions	<ul style="list-style-type: none"> <li>Register Permitted FAX numbers or Permitted ID numbers.*<sup>1</sup></li> <li>➔ <a href="#">Registering Permit FAX No. (page 8-17)</a> <a href="#">Registering Permit ID No. (page 8-20)</a></li> <li>Send restriction settings are specified in <b>[Permit List + Address Book]</b> in Send Restrictions.</li> <li>➔ <a href="#">Setting Send Restriction (page 8-22)</a></li> <li>Register the Local FAX Numbers or Local FAX IDs of other parties.</li> </ul>	<ul style="list-style-type: none"> <li>The recipient's Local FAX Number matches a Permitted FAX No. registered on the machine.</li> <li>The recipient's Local FAX ID matches a Permitted ID registered on the machine.</li> <li>When the number was dialed using the Address Book or One Touch Key, the last 4 digits of the dialed number match the last 4 digits of the recipient's Local FAX Number. (Excludes manual transmissions.)</li> </ul>
Reception Restrictions	<ul style="list-style-type: none"> <li>Register Permitted FAX numbers or Permitted ID numbers.*<sup>2</sup></li> <li>➔ <a href="#">Registering Permit FAX No. (page 8-17)</a> <a href="#">Registering Permit ID No. (page 8-20)</a></li> <li>Reception restriction settings are specified in <b>[Permit List + Address Book]</b> in Reception Restrictions.</li> <li>➔ <a href="#">Setting Reception Restriction (page 8-22)</a></li> <li>Register the Local FAX Numbers or Local FAX IDs of other parties.</li> </ul>	<ul style="list-style-type: none"> <li>The sender's Local FAX Number matches a Permitted FAX No. registered on the machine.</li> <li>The sender's Local FAX ID matches a Permitted ID registered on the machine.</li> <li>A fax number that matches the last 4 digits of the sender's Local FAX Number is registered in the Address Book on this machine.</li> </ul>

\*1 If there is neither a Permitted FAX No. nor a Permitted ID No. registered for the recipient, sending is not rejected.

\*2 If there is neither a Permitted FAX No. nor a Permitted ID No. registered for the sender, reception is not rejected.

	Prerequisites	Reception Rejection Requirements
Reception Rejection	<ul style="list-style-type: none"> <li>Register Reject FAX numbers.*<sup>1</sup></li> <li>➔ <a href="#">Registering Reject FAX No. (page 8-19)</a></li> <li>Reception restriction settings are specified in <b>[Reject List]</b> in Reception Restrictions.</li> <li>➔ <a href="#">Setting Reception Restriction (page 8-22)</a></li> </ul>	<ul style="list-style-type: none"> <li>The sender's Local FAX Number is not registered.</li> <li>The sender's Local Fax Number matches a Reject FAX No. registered on the machine.</li> </ul>

\*1 If there are no Reject FAX numbers registered, calls are only rejected from senders whose Local FAX Numbers (Indicates local FAX information entries, not the actual line numbers.) are not registered.

## Registering Permit FAX No.



### NOTE

Up to 50 Permit FAX numbers can be registered.

### 1 Display the screen.

[System Menu/Counter] key > **[FAX]** > "TX/RX Restriction" **[Next]** > "Permit No. List" **[Add/Edit]**

### 2 Add a permit fax number.

1 Select **[Add]**.

2 Use the numeric keys to enter Permit FAX No. Up to 20 digits can be entered.



### NOTE

Select **[Pause]** to insert a pause (-) between numbers.

Select **[Space]** to enter a space.

Use [**<**] or [**>**] to move the cursor.

Selecting **[Backspace]** deletes the character to the left of the cursor.

3 Select **[OK]**.

### 3 To register another permit fax number, repeat Steps 2-1 to 2-3.

## Changing Permit FAX No.

### 1 Display the screen.

[System Menu/Counter] key > [FAX] > "TX/RX Restriction" [Next] > "Permit No. List" [Add/Edit]

### 2 Changing

- 1 Select [Detail] for Permit FAX No. you want to change, and enter the new number.



#### NOTE

For the procedure for entering a number, refer to the following:

➔ [Registering Permit FAX No. \(page 8-17\)](#)

- 2 [OK] > [Yes]  
The registration is changed.

## Deleting Permit FAX No.

### 1 Display the screen.

[System Menu/Counter] key > [FAX] > "TX/RX Restriction" [Next] > "Permit No. List" [Add/Edit]

### 2 Deleting

- 1 Select Permit FAX No. you want to delete, and select [Delete].
- 2 Select [Yes].  
The registration is deleted.

## Registering Reject FAX No.



### NOTE

Up to 50 Reject FAX numbers can be registered.

### 1 Display the screen.

[System Menu/Counter] key > [FAX] > "TX/RX Restriction" [Next] > "Reject No. List" [Add/Edit]

### 2 Add a Reject FAX No.

1 Select [Add].

2 Use the numeric keys to enter Reject FAX No. Up to 20 digits can be entered.



### NOTE

Select [Pause] to insert a pause (-) between numbers.

Select [Space] to enter a space.

Use [<] or [>] to move the cursor.

Selecting [Backspace] deletes the character to the left of the cursor.

3 Select [OK].

### 3 To register another Reject FAX No., repeat Steps 2-1 to 2-3.

## Changing Reject FAX No.

### 1 Display the screen.

[System Menu/Counter] key > [FAX] > "TX/RX Restriction" [Next] > "Reject No. List" [Add/Edit]

### 2 Changing

1 Select [Detail] for Reject FAX No. you want to change.

2 Enter the new number.



### NOTE

For the procedure for entering a number, refer to the following:

➔ [Registering Reject FAX No. \(page 8-19\)](#)

3 [OK] > [Yes]  
The registration is changed.

## Deleting Reject FAX No.

### 1 Display the screen.

[System Menu/Counter] key > [FAX] > "TX/RX Restriction" [Next] > "Reject No. List" [Add/Edit]

### 2 Deleting

- 1 Select Reject FAX No. you want to delete, and select [Delete].
- 2 Select [Yes].  
The registration is deleted.

## Registering Permit ID No.



### NOTE

Up to 25 Permit ID numbers can be registered.

### 1 Display the screen.

[System Menu/Counter] key > [FAX] > "TX/RX Restriction" [Next] > "Permit ID List" [Add/Edit]

### 2 Add a Permit ID No.

- 1 Select [Add].
  - 2 Use [+]/[-] or the numeric keys to enter Permit ID No. (0000 to 9999).
  - 3 Select [OK].
- 3 To register another Permit ID No., repeat Steps 2-1 to 2-3.**

## Changing Permit ID No.

### 1 Display the screen.

[System Menu/Counter] key > [FAX] > "TX/RX Restriction" [Next] > "Permit ID List" [Add/Edit]

### 2 Changing

- 1 Select [Detail] for Permit ID No. you want to change.
- 2 Enter the new number.



#### NOTE

For the procedure for entering a number, refer to the following:

➔ [Registering Permit ID No. \(page 8-20\)](#)

- 3 [OK] > [Yes]  
The registration is changed.

## Deleting Permit ID No.

### 1 Display the screen.

[System Menu/Counter] key > [FAX] > "TX/RX Restriction" [Next] > "Permit ID List" [Add/Edit]

### 2 Deleting

- 1 Select Permit ID No. you want to delete, and select [Delete].
- 2 Select [Yes].  
The registration is deleted.

## Setting Send Restriction

Restrict the other parties to which you send originals only to the ones registered in Permit FAX No. and Permit ID No. as well as the ones registered in the Address Book. To change the sending restriction, follow the steps below.

### 1 Display the screen.

[System Menu/Counter] key > [FAX] > "TX/RX Restriction" [Next] > "TX Restriction" [Change]

### 2 Configure the function.

To not use the sending restriction, select [Off].

To restrict the other parties to which you send originals only to the ones registered in Permit FAX No. and Permit ID No. as well as the ones registered in the Address Book, select [Permit List + Address Book].

## Setting Reception Restriction

Restrict incoming faxes so that you only receive originals from senders registered in Permit FAX No. and Permit ID No. and senders registered in your Address Book. This mode also allows you to set a [Reject List] for Reception Restriction so that reception from senders on the list of Rejected FAX numbers or from senders whose Local FAX Number is not registered are rejected. (You can select whether reception from a party whose local fax number is not registered is allowed or rejected in "Unknown Number Reception".)

➔ [Unknown Number Reception \(page 8-23\)](#)

To change the reception restriction, follow the steps below.

### 1 Display the screen.

[System Menu/Counter] key > [FAX] > "TX/RX Restriction" [Next] > "RX Restriction" [Change]

### 2 Configure the function.

**To not use the reception restriction**

Select [Off] > [OK]

**To restrict the other parties from which you receive originals only to the ones registered in Permit FAX No. and Permit ID No. as well as the ones registered in the Address Book**

Select [Permit List + Address Book] > [OK]

**To block incoming faxes from senders registered in Reject FAX No.**

Select [Reject List] > [OK]

## Unknown Number Reception

Select whether to receive the fax of that the number is unknown when **[Reject List]** is set for Reception Restriction.

To change the reception restriction for the unknown fax number, follow the steps below.

### **1** Display the screen.

[System Menu/Counter] key > **[FAX]** > "TX/RX Restriction" **[Next]** > "Unknown No. Reception"  
**[Change]**

### **2** Configure the function.

**To receive faxes from the unknown number**

Select **[Permit]** > **[OK]**

**To reject faxes from the unknown number**

Select **[Reject]** > **[OK]**



# Unusable Time

This feature sets a time period during which the machine will not print received faxes.

## IMPORTANT

When Unusable Time is set, in addition to fax printing, all other printing operations are prohibited during the unusable time period, including printing of copy jobs and printer jobs, and printing from USB Drive.

Faxes and print jobs received during the unusable time period are printed after the unusable time period ends, or when the unusable time period is temporarily canceled.

## NOTE

If user login administration is enabled, you can only change the settings by logging in with administrator privileges or as a user with privileges to configure this setting.

The factory default login user name and login password are set as shown below.

Model Name	Login User Name	Login Password
TASKalfa 2553ci	2500	2500
TASKalfa 3253ci	3200	3200
TASKalfa 3553ci	3500	3500
TASKalfa 4053ci	4000	4000
TASKalfa 5003i/TASKalfa 5053ci	5000	5000
TASKalfa 6003i/TASKalfa 6053ci	6000	6000
TASKalfa 7003i	7000	7000
TASKalfa 7353ci	7300	7300
TASKalfa 8003i	8000	8000
TASKalfa 8353ci	8300	8300
TASKalfa 9003i	9000	9000

## 1 Display the screen.

[System Menu/Counter] key > [Date/Timer/Energy Saver] > "Unusable Time" [Change]

## 2 Configure the function.

### Set the unusable time

Select [On] and use [+] or [-] to enter the start time and end time.

## NOTE

If the same time is set as the start time and end time, you cannot use all day.

### Set the cancel code

Specify the code to temporarily cancel the unusable setting during unusable time.

- 1 Select [**Unlock code**].
- 2 Enter Unlock Code (0000 to 9999).
- 3 Select [**OK**].
- 4 [**OK**] > [**OK**]



#### **NOTE**

To use the machine temporarily during unusable time, enter the Unlock Code and select [**Login**].

# Account Management

Account management is user management that specifies the users who can use the machine and job accounting that controls the usage per account. In user accounting, up to 1,000 users can be managed using User ID and Password. In job accounting, the status of fax use per account can be known for up to 1,000 accounts for sending of originals and making communication reservation after entering Account ID. For each management method, refer to the following:

## ➔ Machine's Operation Guide

It will be necessary to log in if user management or department management are enabled. For the method for logging in, refer to the following:

➔ [Login/Logout \(page 3-17\)](#)

### Description of User Accounting

Item	Description
Registration of User	Register user access privileges, User ID and Password.
Enable/Disable User accounting	Enable User accounting.



#### NOTE

➔ Machine's Operation Guide

### Description of Job Accounting

Item	Description
Registration of Account	Register Account Name and Account ID. Up to 8 digits can be entered.
Enable/Disable job accounting	Enable job accounting.
FAX send restriction	Restricts the number of fax sheets that can be sent. You can prohibit the use of this sending function or cancel the sending restriction.
Fax port restriction <sup>*1</sup>	Restricts the ports used.
Counting of the number of used sheets	You can reset the counting, referring to the number of fax sheets to be sent and the time required for sending fax by all the accounts or by account.
Print of Accounting Report	You can print the printed and sent page numbers that have been counted by all the accounts.

\*1 This function is displayed when 2 optional FAX Kits (Dual FAX option) are installed.



#### NOTE

➔ Machine's Operation Guide

### Communication modes subject to job accounting

- Normal transmission
- Delayed transmission
- Broadcast transmission
- Sub address transmission
- Encrypted transmission
- Manual send when dialed from this machine to the receiving system
- Polling reception
- Sending Faxes from PC (Destinations include FAX and i-FAX destinations.)
- i-FAX Transmission
- Transmission from the document box

### Restriction of use function

When you have enabled job accounting, you need to enter an Account ID when performing the following operations.

- Normal transmission
- Delayed transmission
- Broadcast transmission
- Sub address transmission
- Output from FAX Box
- Encrypted transmission
- Manual send when dialed from this machine to the receiving system
- Polling reception
- Sending Faxes from PC (Destinations include FAX and i-FAX destinations.)
- i-FAX Transmission
- Transmission from the document box



#### **IMPORTANT**

**You can use 'Make a call', 'Checking FAX Job History' and 'Communication Control Report Output' functions without entering an Account ID or Administrator No.**

When job accounting has been enabled, batch transmission function works only for communication to be performed for the same Account ID. The communication to be performed with a different Account ID is not conducted as a batch transmission.

Normally, the Local FAX Name is printed in the transmit terminal identification (TTI). However, when job accounting is enabled and an Account ID is entered when a fax is sent, you can enable a setting to have the Account Name or Local FAX Name, whichever was selected, be printed.

➔ [Account as Local FAX Name \(page 8-10\)](#)

# 9 Optional Equipment

This chapter introduces the optional equipment available for the FAX kit.

Internet FAX Kit(A) "Internet FAX Kit" .....	9-2
Dual FAX.....	9-3
Dual FAX Settings.....	9-3
Reception Port Selection .....	9-3
Job Accounting Port Restrictions.....	9-4

## Internet FAX Kit(A) "Internet FAX Kit"

You can use Internet FAX on this machine.

➔ [Internet Faxing \(i-FAX\) \(page 10-1\)](#)

## Dual FAX

Installing 2 optional FAX Kits (Dual FAX option) allows you to use 2 phone lines. This reduces the time until faxes are sent to all the recipients in tasks such as sequential broadcast transmissions to multiple recipients. Also, because you can then send and receive simultaneously, there will be fewer occasions when you cannot receive a fax during fax transmission.

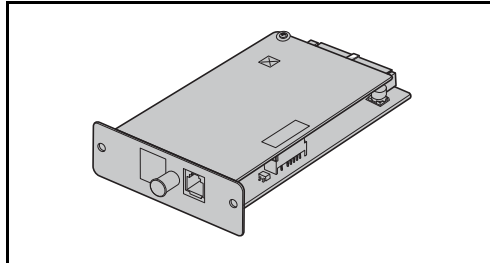

## Dual FAX Settings

Specifying the settings for the second line.

➔ [Transmission \(page 8-10\)](#)

## Reception Port Selection

You can make one of the 2 phone lines a receive-only line.

### 1 Display the screen.

[System Menu/Counter] key > [FAX] > "Reception" [Next] > "FAX" [Next] > "Reception Port" [Change]

### 2 Configure the settings.

1 Select a receive-only port. If you do not want to set up a receive-only port, select [Off].

2 Select [OK].

## Job Accounting Port Restrictions

If job accounting is enabled, you can restrict access so that departments can only use one port.

### 1 Display the screen.

- 1 [System Menu/Counter] key > **[User Login/Job Accounting]**



#### NOTE

If the user authentication screen appears, enter your login user name and login password and select **[Login]**.

The factory default login user name and login password are set as shown below.

Model Name	Login User Name	Login Password
<b>TASKalfa 2553ci</b>	2500	2500
<b>TASKalfa 3253ci</b>	3200	3200
<b>TASKalfa 3553ci</b>	3500	3500
<b>TASKalfa 4053ci</b>	4000	4000
<b>TASKalfa 5003i/TASKalfa 5053ci</b>	5000	5000
<b>TASKalfa 6003i/TASKalfa 6053ci</b>	6000	6000
<b>TASKalfa 7003i</b>	7000	7000
<b>TASKalfa 7353ci</b>	7300	7300
<b>TASKalfa 8003i</b>	8000	8000
<b>TASKalfa 8353ci</b>	8300	8300
<b>TASKalfa 9003i</b>	9000	9000

- 2 "Job Accounting Setting" **[Next]** > "Job Accounting (Local)"**[Next]** > "Accounting List" **[Add/Edit]** > **[Add]** > "FAX Port Restriction" **[Change]**

### 2 Configure the settings.

**[Off]**, **[Use Port 1 Only]**, or **[Use Port 2 Only]** > **[OK]**

For detailed information on restrictions and job accounting, refer to the following:

- ➔ Machine's *Operation Guide*



# 10 Internet Faxing (i-FAX)

This chapter explains how to use the Internet faxing (i-FAX) using the Internet FAX Kit.

What is i-FAX? .....	10-2
i-FAX Settings .....	10-5
Accessing Command Center RX .....	10-5
i-FAX Default Settings.....	10-6
i-FAX transmission procedure .....	10-10
Checking the Send Status .....	10-12
i-FAX Reception .....	10-13

## What is i-FAX?

The i-FAX function sends and receives faxes via the Internet without using a phone line.

The main features of i-FAX are:

- It reduces communication costs since it does not use a phone line.
  - Address books (on this machine or on a computer) can be used to specify destinations.
  - Faxes can be sent to multiple recipients simultaneously.
  - Memory forwarding can be used to forward faxes received by this machine to multiple recipients as Internet faxes.
- ➔ [Memory Forwarding \(page 5-2\)](#)
- E-mail notification of transmission results
  - Direct SMTP is supported, which enables direct communication (without going through a mail server) with a machine that supports Internet fax and is connected via LAN. Real time transmission and reception are possible.

### Example of sending i-FAX

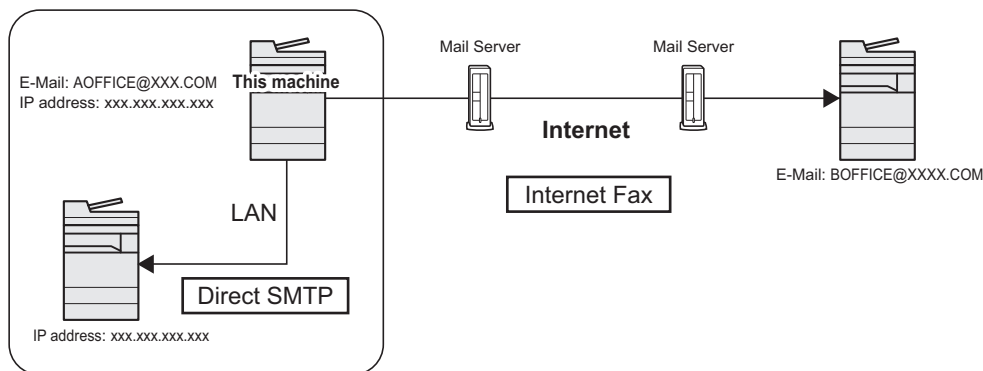

### i-FAX Transmission Flowchart

The procedure for sending an i-FAX is shown below.

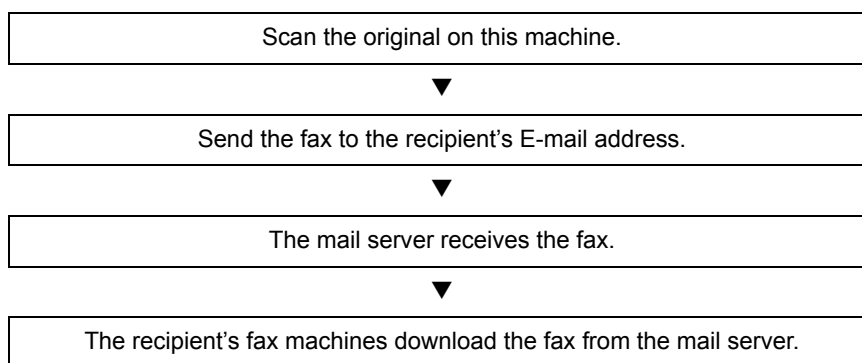

#### NOTE

When Direct SMTP is used, communication does not go through a mail server, and thus a document scanned on your machine is sent directly to the destination Direct SMTP compliant machine.

## i-FAX Reception Flowchart

The procedure for receiving an i-FAX is shown below.

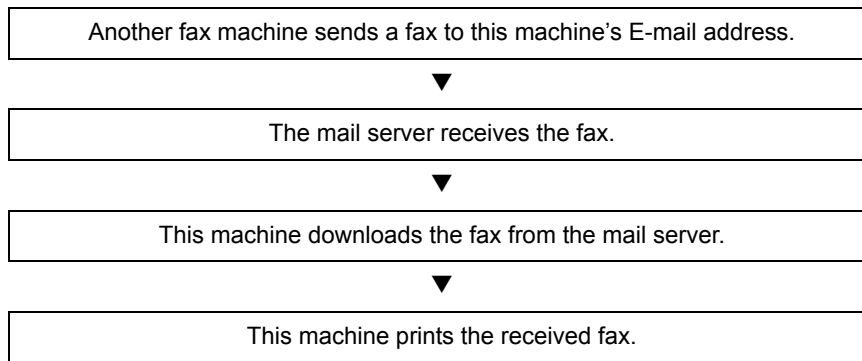

### NOTE

When Direct SMTP is used, communication does not go through a mail server, and thus your machine directly receives and prints a document sent from another fax machine.

## Notes on Using i-FAX

- To use i-FAX, you must connect this machine to a computer using a network cable and specify the network settings.  
➔ [i-FAX Settings on page 10-5](#)
- If you cannot successfully send an i-FAX to the recipient, you normally receive an E-mail error message from the server. However, in some cases problems can arise such that you do not receive the error message. For important faxes, you should contact the recipient to check whether the fax was successfully received.
- Due to the low level of security in Internet communication, important documents should be faxed over a direct telephone line.
- Communication over the Internet may take some time due to network congestion or communication faults. Urgent faxes should be sent over a direct telephone line.
- Because Internet faxing sends the faxed originals as files attached to an E-mail message, you cannot communicate directly with the recipient.
- You cannot have a telephone conversation via the Internet.
- The resolution, compression mode and paper sizes that you can use for transmissions are dependent on the performance of the receiving machine. Check the specifications of the receiving machine before sending the fax. If you do not know the specifications of the receiving machine, the recommended transmission settings are a resolution of 200 × 200 dpi, the MH compression mode and a paper size of A4.
- If only Direct SMTP, which does not go through a mail server, will be used, the SMTP settings / POP3 server settings in the i-FAX settings are not necessary.

## Functions not available when sending an i-FAX

The following functions are not available when sending an i-FAX. They are available when sending a normal fax.

- Delayed transmission
- Encrypted transmission
- Direct transmission
- Sub address transmission
- Polling transmission
- Send restriction by registering permitted FAX numbers
- Transmission using ECM communication
- Send restriction by registering permitted ID numbers

## Functions not available when receiving an i-FAX

The following functions are not available when receiving an i-FAX. They are available when sending a normal fax.

- Reception using a sub address
- Polling reception
- Encrypted reception
- Reception restriction by registering permitted FAX numbers
- Reception restriction by registering permitted ID numbers
- Reception rejection by registering reject FAX numbers

## Full Mode

This machine supports full-mode Internet faxing that conforms to the ITU-T T.37 recommendations. If the other party's machine also supports full mode, you can use transmission confirmation when you send a fax to check that it successfully reached the recipient's machine.

## When this machine receives an i-FAX

The machine sends reception capacity information in response to a transmission confirmation request from the sender. Information on the resolutions, compression modes and paper sizes supported by this machine is sent to the sender.

## When this machine sends an i-FAX

The machine sends a transmission confirmation to recipients who selected full mode. Transmission confirmation results sent back by recipients are included in the sent fax report.

For more information on sent fax reports, refer to the following:

➔ [Printing Activity Reports \(page 7-10\)](#)

For more information on setting the conditions for destination machines, refer to the following:

➔ [Registering a contact address \(i-FAX\) \(page 2-19\)](#)  
[i-FAX transmission procedure \(page 10-10\)](#)

# i-FAX Settings

To send and receive Internet faxes, you must first specify the SMTP server and POP3 server settings. Specify these settings using Command Center RX on a computer that is connected to this machine via a network. Refer to the machine's *Operation Guide* for information on the network settings.

## Accessing Command Center RX

### 1 Display the screen.

- 1 Launch your Web browser.
- 2 In the address or location bar, enter the machine's IP address or the host name.  
Examples: 10.180.81.3/ (for IP address)  
MFP001 (if the host name is "MFP001")

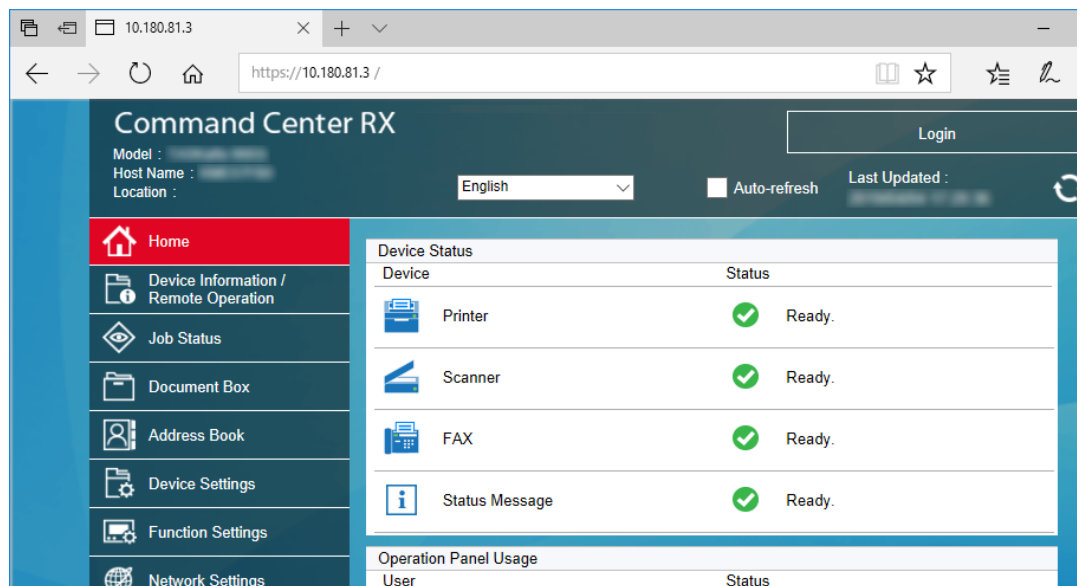

The web page displays basic information about the machine and Command Center RX as well as their current status.

#### NOTE

If the screen "There is a problem with this website's security certificate." is displayed, configure the certificate.

➔ [Command Center RX User Guide](#)

You can also continue the operation without configuring the certificate.

- 3 Enter the user name and password of the administrator, and click Login. Setting Administrator User Name, and Password restricts general users' access to pages other than the Start page. For security purposes, setting the Administrator password is highly recommended. The default Administrator password is factory-set as 'Admin'.
- 4 Click 'Function Settings' from the navigation bar on the left to view and set values for that particular category.
- 5 Click 'FAX / i-FAX'. The Transmit Settings dialog box will appear.  
➔ [Command Center RX User Guide](#)

## i-FAX Default Settings

### Function Settings > FAX / i-FAX

Use this page to enable the internet faxing.

The settings available on the page are shown below.

Item		Description	
Common Settings	Transmission	Local FAX Name	Enter the local fax name.
		TTI	Selects On or Off whether to send the TTI (Transmit Terminal Identifier) information to the other party.
		TTI Position	Selects the position of the TTI to be printed on the transmitted documents.
		Account as Local FAX Name	Set to On to use the account name as the local FAX name. The account name appears in place of the local FAX name.
		Retry Times	Specify the number of redials.
	Reception	Media Type	Sets the media type for printing the received documents.
		Use MP Tray	Selects whether or not to include the MP (multipurpose) tray for auto media selection when printing received documents. When turned <b>[On]</b> , the MP tray will be included as an option for auto media selection, and when turned <b>[Off]</b> , only the cassettes will be selected.
		FAX Exclusive Paper Source	Set fax exclusive paper cassettes.
		Reduced RX Size	When the reception size is larger than the paper size, you can reduce the print size.
		Receive Date/Time	Selects <b>[On]</b> or <b>[Off]</b> whether to print the reception information such as the received date, the received time, the transmitting party's information and the number of transmitted pages on the top of the received documents.
		Duplex Printing	Specifies whether or not to use the Duplex mode.
		2in1 Printing	Enables or disables 2 in1 reception.
		FAX Settings	Configure settings for FAX. ➔ <i>Command Center RX User Guide</i>

Item		Description
i-FAX Settings	TX/RX	i-FAX Protocol <sup>*1, *2</sup> Display whether an i-FAX connection is available or not. Configure i-FAX in [ <b>i-FAX (SMTP &amp; POP3)</b> ] on the Protocol Settings page.
	SMTP	SMTP Server Name <sup>*2</sup> Enter the SMTP server name or SMTP server IP address. You can enter up to 64 characters. If you enter the server name, you must specify the IP address of the DNS server. You can enter the DNS server IP address in the TCP/IP settings screen. ➔ <i>Machine's Operation Guide</i>
		SMTP Port Number Set the port number used by SMTP. Normally, 25 is used.
		SMTP Server Timeout Enter the timeout period in seconds.
		Authentication Protocol Specify whether SMTP authentication will be used or whether [ <b>POP before SMTP</b> ] will be used.
		POP before SMTP Timeout If you selected [ <b>POP before SMTP</b> ] in the authentication setting, specify the timeout period in seconds.
		Connection Test Tests to confirm that the settings on this page are correct. When the [ <b>Test</b> ] button is clicked, this machine tries to connect to the SMTP server.
		Domain Restriction Activate or deactivate to restrict domains. Click the [ <b>Domain List</b> ] button to configure. Enter a domain name that is permitted or rejected. You can also specify the E-mail addresses.

\*1 When Direct SMTP is used, this must always be set.

\*2 When Internet FAX is used, this must always be set.

Item		Description	
i-FAX Settings	POP3	Check Interval	Displays the interval, in minutes, for connecting to the POP3 server to check for incoming e-mails at specific interval. Specify the interval in the range from 3 minutes to 60 minutes. The default is 15 minutes.
		Run once now	Click <b>[Receive]</b> to immediately connect to the POP3 server and check for incoming E-mail.
		Domain Restriction	Activate or deactivate to restrict domains. Click the <b>[Domain List]</b> button to configure. Enter a domain name that is permitted or rejected. You can also specify the E-mail addresses.
	POP3 User Settings		—
	E-mail Address <sup>*1</sup>		Enter the i-FAX address (E-mail address). You can enter up to 64 characters.
	POP3 Server Name <sup>*1</sup>		If you enter the server name, you must specify the IP address of the DNS server. You can enter the DNS server IP address in the TCP/IP settings screen.  ➔ <i>Machine's Operation Guide</i>
	POP3 Port Number		Sets the port number used by POP3. Normally, 110 is used.
	POP3 Server Timeout		Enter the timeout period in seconds.
	Login User Name <sup>*1</sup>		Enter the login name for the user account. You can enter up to 64 characters.
	Login Password <sup>*1</sup>		Enter the password for the user account. You can enter up to 64 characters.
	Use APOP		Specify whether to use APOP authentication. To use APOP authentication, select <b>[On]</b> in this setting.
	Connection Test		Runs a test to determine whether the settings specified in this page are correct.
	E-mail Size Limit		Enter the maximum size for E-mails that can be received in kilobytes. You can set up to 32,767 kilobytes. If 0 is entered, the setting does not limit the maximum size.
Cover Page		Specify whether the E-mail messages are also printed. Select <b>[On]</b> to print faxes with a cover page attached. If the E-mail message includes text, the text is printed on the cover page.	

\*1 When Internet FAX is used, this must always be set.



Item		Description	
i-FAX Settings	Transmission	Transmission Type	Allows to choose a method of sending from [ <b>Specify for Each Destination</b> ], [ <b>Via server - On</b> ], and [ <b>Via server - Off (Direct SMTP)</b> ].
		Direct SMTP Sender Address <sup>*1</sup>	Displays the sender address used for E-mails sent by Direct SMTP from this machine.
		Direct SMTP Port Number	Enter the port number used by Direct SMTP. Normally, 25 is used.
		Direct SMTP Timeout	Sets the timeout time in seconds during which this device retries to connect to the SMTP server.
	Reception	Direct SMTP Port Number	Enter the port number used by Direct SMTP. Normally, 25 is used.
		Direct SMTP Timeout	Sets the timeout time in seconds during which this device retries to connect to the SMTP server.
	E-mail Send Settings	E-mail Size Limit	Enter the maximum size of E-mail that can be sent in Kilobytes. When the value is 0, the limitation for E-mail size is disabled.
		Sender Address <sup>*2</sup>	Displays the sender address used for E-mails sent from this machine. Set in [ <b>E-mail Address</b> ] in <i>POP3 User Settings</i> .
		Signature	Displays the signature to be inserted in the end of the E-mail body. Set on the [ <b>E-mail Settings</b> ] page.
		Function Default	The default settings can be changed in [ <b>Common/ Job Default Settings</b> ] page.

\*1 When Direct SMTP is used, this must always be set.

\*2 When Internet FAX is used, this must always be set.

After completing the settings, click [**Submit**] to save the settings.

# i-FAX transmission procedure

The basic procedure for using the fax system is explained below.

## 1 Select [Send] key on the Home screen.

## 2 Place the originals.

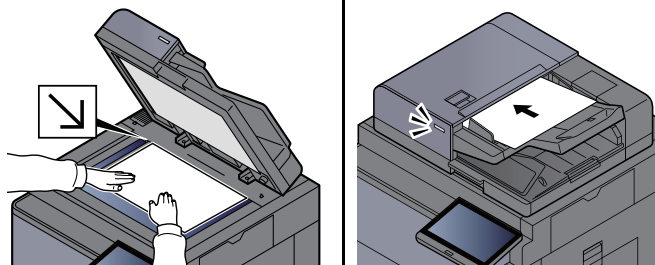

### NOTE

The illustration varies between models.

For placing originals, refer to the following:

➔ [Machine's Operation Guide](#)

## 3 Specifying destination.

### 1 [i-FAX Addr Entry] > [i-FAX Address]

### 2 Enter the destination address > [OK]

You can enter up to 256 characters.

➔ [Character Entry Method \(page 12-2\)](#)

For a Direct SMTP address, which does not go through a server, specify only the IP address of the other machine, or specify any name using half-width alphanumeric characters in the format "name@[IP address of other machine]".

Example: officeA@192.168.48.21

### Dialing methods without using the numeric keys

- ➔ [Choosing from the Address Book \(page 3-9\)](#)
- [Choosing from the One Touch Key \(page 3-11\)](#)
- [Choosing from the Speed Dial \(page 3-11\)](#)
- [Using redial \(page 3-3\)](#)



### NOTE

When *On* is selected in *Entry Check for New Dest.*, a confirmation screen is displayed for the entered FAX number. Re-enter the same FAX number and select [OK].

➔ [Machine's Operation Guide](#)

When [Add to Addr Book] is displayed, you can register entered contents to the Address Book.

In addition to an i-fax, you can include FAX transmission, e-mail transmission and folder (SMB/FTP) transmission to send as one job.

➔ [Machine's Operation Guide](#)

When the destination includes FAX or i-FAX, the FAX or i-FAX jobs are sent in monochrome and the other sending jobs are sent as the same color as the scanned originals.

## 4 Configure the detailed settings.

- 1 "Mode" [▼] > [Simple] or [Full]
- 2 "Via Server" [▼] > [On] or [Off].  
 When this setting is set to [Off], transmission takes place by direct SMTP (not through an e-mail server).  
 When this setting is set to [On], transmission takes place by the i-FAX method (through an e-mail server).



### NOTE

The settings are automatically configured based on the i-FAX transmission type that is set in Command Center RX. When the transmission type is set to [Specify for Each Destination], these settings can be configured.

## 5 Specifying the Destinations Conditions.

Select [Destination Condition].

The available settings are shown below.

Item	Description
<b>Resolution</b>	<p>Specify the resolutions that can be received by the destination fax machine.</p> <p>If you try to send an i-FAX using a prohibited resolution, it is automatically changed to a permitted resolution and then sent.</p> <ul style="list-style-type: none"> <li>• 200 × 100 dpi: Permitted (fixed)</li> <li>• 200 × 200 dpi: Permitted (fixed)</li> <li>• 200 × 400 dpi: Permitted or prohibited</li> <li>• 400 × 400 dpi: Permitted or prohibited</li> <li>• 600 × 600 dpi: Permitted or prohibited</li> </ul> <p>To permit a resolution setting, press the key for that resolution so that it is highlighted.</p> <p>To prohibit a resolution, press the key again so that it is no longer highlighted.</p>
<b>Compression</b>	<p>Select a suitable file format for the destination fax machine.</p> <p>MH, MR, MMR or JBIG</p>
<b>Paper Size</b>	<p>Display the sending paper size for the destination fax machine. If you try to send an i-FAX using a prohibited paper size, it is automatically changed to a permitted paper size and then sent.</p> <ul style="list-style-type: none"> <li>• A4/Letter: Permitted (fixed)</li> <li>• B4: Permitted or prohibited</li> <li>• A3/Ledger: Permitted or prohibited</li> </ul>

## 6 Selecting the functions.

➔ [Fax transmission functions \(page 3-19\)](#)

Grayed out items cannot be set.

## 7 Press the [Start] key.

When scanning finishes, transmission starts.

## Checking the Send Status

**1** Select the **[Status/Job Cancel]** key.

**2** Display the send job status screen.

Select **[Sending Jobs]**.

The list of accepted time, destination, and status are displayed for each job.

# i-FAX Reception

At set intervals, this machine connects to the mail server and automatically downloads and prints any Internet faxes found on the server. No particular user intervention is needed when the machine receives an i-FAX.

## NOTE

When Direct SMTP reception (communication without a mail server) is used, your machine connects directly to the sending machine instead of connecting to an external mail server. Because your machine connects directly to the other machine, reception takes place immediately without the need to execute manual reception, which is an operation that queries the server.

You can change the following reception settings:

➔ [POP3 \(page 10-8\)](#)

- i-FAX address registration
- Incoming E-mail check interval setting
- Cover page (E-mail information) printing

## Manual i-FAX Reception

Use this procedure to check for faxes immediately.

### 1 Display the screen.

[Status/Job Cancel] key > [Device/Communicate]

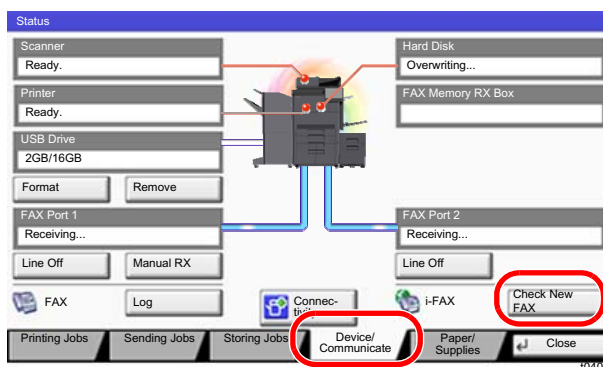

## NOTE

The image of the touch panel varies between models.

### 2 Receive an i-FAX.

Select "i-FAX" [Check New FAX].

The machine connects to the mail server and starts downloading any Internet faxes it finds.

# 11 Troubleshooting

This chapter explains the following topics:

Indicators During Sending/Receiving Operation .....	11-2
Responding to an Attention Indicator Flashes .....	11-2
Precautions When Turning Power OFF .....	11-3
Messages .....	11-4
Error Code List .....	11-6
Troubleshooting .....	11-10
Common inquiries .....	11-13

# Indicators During Sending/Receiving Operation

The **[Data]** (▶▶) indicator show the fax transmission status.

- The **[Data]** (▶▶) indicator blinks during fax transmission and reception.
- The **[Data]** (▶▶) indicator is lit when there is source data stored in the memory for delayed transmission.



## Responding to an Attention Indicator Flashes

If the **[Attention]** ( ! ) indicator flashes, select the **[Status/Job Cancel]** key to check an error message. If the message is not indicated on the touch panel when the **[Status/Job Cancel]** key is pressed or the attention indicator flashes, check the following.

Symptom	Checkpoints	Corrective Actions	Reference Page
Cannot send fax.	Is the modular cord connected correctly?	Connect the modular cord correctly.	—
	Is Permitted FAX No. or Permitted ID No. registered correctly?	Check Permitted FAX No. and Permitted ID No.	<a href="#">8-16</a>
	Has a communication error occurred?	Check error codes in the TX/RX Result Report and Activity Report. If the error code starts with "U" or "E", perform the corresponding procedure.	<a href="#">11-6</a>
	Is the destination FAX line busy?	Send again.	—
	Does the destination FAX machine respond?	Send again.	—
	Is there an error other than above?	Contact your Service Representative.	—

## Precautions When Turning Power OFF

To power off the machine, press the Power switch. You cannot automatically receive a fax when the power switch is turned off.

### 1 Turn the power switch off.

TASKalfa 6053ci/TASKalfa 5053ci/  
TASKalfa 4053ci/TASKalfa 3553ci/  
TASKalfa 3253ci/TASKalfa 2553ci/  
TASKalfa 6003i/TASKalfa 5003i

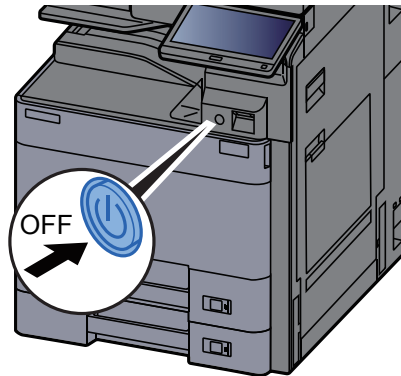

TASKalfa 8353ci/TASKalfa 7353ci/  
TASKalfa 9003i/TASKalfa 8003i/  
TASKalfa 7003i

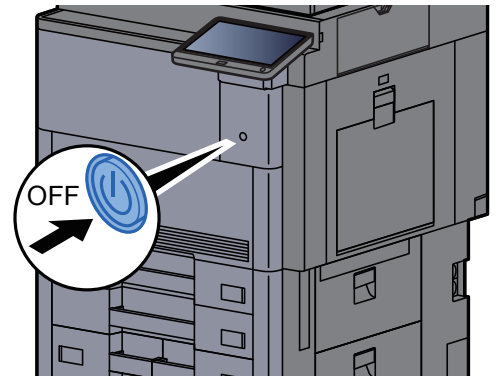

The confirmation message for power supply off is displayed.

It takes about 3 minutes for power off.



# Messages

When an error occurs, the display may show one of the messages listed below. These will help you identify and correct the problem.



**NOTE**

When a transmission error occurs, a sent/receipt result report is produced.

Check the error code shown in the report and refer to the following:

- ➔ [Error Code List \(page 11-6\)](#)

To print the sent/receipt result report, refer to the following:

- ➔ [Send Result Reports \(page 7-7\)](#)
- ➔ [FAX RX Result Reports \(page 7-9\)](#)

You may also check error codes using the activity report.

- ➔ [Activity Report \(Outgoing FAX Report and Incoming FAX Report\) \(page 7-10\)](#)

Message	Checkpoint	Corrective Action	Reference Page
<b>Add paper in cassette #.</b>	Is the indicated cassette out of paper?	Load paper.	—
<b>Box limit exceeded.</b>	Is <b>[End]</b> displayed on the screen?	The specified box is full, and no further storage is available. Job is canceled. Select <b>[End]</b> . Try to perform the job again after printing or deleting data from the box.	<a href="#">5-34</a>
<b>Cannot process this job.</b>	—	This job is canceled because it is restricted by User Authorization or Job Accounting. Select <b>[End]</b> .	—
<b>Check the paper in the multipurpose tray.</b>	—	The paper size is different. Set selected size paper and select <b>[Continue]</b> .	—
<b>FAX box limit exceeded.</b>	—	Follow the instructions on the screen and delete documents from the FAX box to make room for FAX reception. To check the canceled job, select the <b>[Status/Job Cancel]</b> key and then <b>[Printing Jobs]</b> to check receipt result.	—
<b>Job Accounting restriction exceeded.</b>	Is the acceptable printing count restricted by Job Accounting exceeded?	The printing count exceeded the acceptable count restricted by Job Accounting. Cannot print any more. This job is canceled. Select <b>[End]</b> .	Refer to the machine's <b>Operation Guide</b> .
<b>Machine failure.</b>	—	Internal error has occurred. Make a note of the error code displayed on the screen. Call service.	—
<b>Scheduled sending jobs exceeded.</b>	—	The number of jobs has exceeded the limit set for delayed transmission. Select <b>[End]</b> . The job is canceled. Wait until the delayed transmission is executed, or cancel the delayed transmission and then perform the job again.	<a href="#">3-26</a>
<b>The phone receiver is off the hook.</b>	—	Put down the receiver.	—





# Error Code List



When a transmission error occurs, one of the following error codes is recorded in the TX/RX Result Report and Activity Report.



**NOTE**

“U” or “E” will appear in the error code depending on the communication speed setting.

Error Code	Possible Cause/Action
Busy	Failed to establish connection with the recipient despite auto redialing the preset number of times. Send again.
CANCELED	Transmission was canceled due to an action to cancel transmission. Reception was canceled due to an action to cancel reception.
E00300 U00300	Paper depletion occurred at the recipient machine. Check with the recipient.
E00430 - E00462 U00430 - U00462	Reception was canceled because of mismatching of communication features with the sender machine although the line connection was established.
E00601 - E00690 U00601 - U00690	Communication was stopped due to the machine failure. Send or receive again.
E00700 U00700	Communication was stopped due to failure on the part of the sender or recipient machine.
E00800 - E00811 U00800 - U00811	Page(s) not sent correctly. Send again. If you still have trouble, reduce TX Start Speed and send again.   <b>NOTE</b> If the communication error occurs frequently, change the default setting of TX Start Speed in System Menu.
E00900 - E00910 U00900 - U00910	Page(s) not received correctly. Ask the sender to resend.   <b>NOTE</b> If the communication error occurs frequently, change the default setting of RX Start Speed in System Menu.
E01000 - E01097 U01000 - U01097	Communication error occurred during transmission. Send again. If you still have trouble, reduce TX Start Speed and send again.   <b>NOTE</b> If the communication error occurs frequently, change the default setting of TX Start Speed in System Menu.
E01100 - E01196 U01100 - U01196	Communication error occurred during reception. Ask the sender to resend.   <b>NOTE</b> If the communication error occurs frequently, change the default setting of RX Start Speed in System Menu.
U01400	Failed to establish communication with the sender or recipient machine because dialing registered for a tone line system was used in a pulse line system.
E01500	Communication error occurred during high-speed transmission. Send again. If you still have trouble, reduce TX Start Speed and send again.   <b>NOTE</b> If the communication error occurs frequently, change the default setting of TX Start Speed in System Menu.

Error Code	Possible Cause/Action
E01600	<p>Communication error occurred during reception of high-speed transmission. Ask the sender to reduce the transmission speed and send again.</p> <p> <b>NOTE</b> If the communication error occurs frequently, change the default setting of RX Start Speed in System Menu.</p>
E01700 - E01720	<p>Communication error occurred during high-speed transmission. Send again. If you still have trouble, reduce TX Start Speed and send again.</p> <p> <b>NOTE</b> If the communication error occurs frequently, change the default setting of TX Start Speed in System Menu.</p>
E01721	<p>Communication error occurred during high-speed transmission. Designated transmission speed may not be available for the recipient machine. Reduce the transmission start speed and send again.</p>
E01800 -E01820	<p>Communication error occurred during reception of high-speed transmission. Ask the sender to reduce the transmission speed and send again or reduce the RX Start Speed in System Menu.</p>
E01821	<p>Communication error occurred during reception of high-speed transmission. Designated transmission speed may not be available for this machine. Ask the sender to reduce the transmission speed and send again or reduce the RX Start Speed in System Menu.</p>
E03000 U03000	<p>During polling reception, a fax could not be received because no originals were set in the other party's fax machine. Check with the other party.</p>
E03200 U03200	<p>Sub address bulletin board reception was attempted and the other party's machine is an our brand model, but the specified sub address box contained no data. Check with the other party.</p>
E03300 U03300	<p>An error occurred due to either 1 or 2 below. Check with the other party.</p> <ol style="list-style-type: none"> <li>1 The other party's machine is an our-brand model and transmission restrictions were found set by the other party during polling reception. Communication was interrupted because the password was incorrect.</li> <li>2 The other party's machine is an our-brand model and transmission restrictions were found set by the other party during sub address bulletin board reception. Communication was interrupted because the password was incorrect.</li> </ol>
E03400 U03400	<p>Polling reception was interrupted because the password entered by the other party did not match the Local FAX ID on the receiving machine. Check with the other party.</p>
E03500 U03500	<p>Sub address bulletin board reception was attempted and the other party's machine is an our brand model, but the specified sub address box was not registered on the other party's machine. Check with the recipient.</p>
E03600 U03600	<p>The other party's machine is an our-brand model and sub address bulletin board reception was interrupted because the specified sub address password was incorrect. Check with the other party.</p>
E03700 U03700	<p>Sub address bulletin board reception was attempted but the other party's machine either does not have a sub address bulletin board communication function or there were no originals in any of the originals transfer boxes (sub address boxes).</p>
E04000 U04000	<p>Specified sub address box is not registered in our brand recipient machine, or the sub address does not match.</p>
E04100 U04100	<p>Recipient machine is not equipped with a sub address box function, or the sub address does not match.</p>

Error Code	Possible Cause/Action
E04200 U04200	Encrypted transmission was canceled because the specified box is not registered.
E04300 U04300	Encrypted transmission was canceled because the recipient fax is not equipped with an encrypted communication function.
E04400 U04400	Encrypted transmission was canceled because the encryption key does not match.
E04500 U04500	Encrypted reception was canceled because the encryption key does not match.
E05100 U05100	Transmission was canceled because communication requirements are not met due to the transmission restriction set on this machine. Check with the recipient.
E05200 U05200	Reception was canceled because communication requirements are not met due to the reception restriction set on this machine.
E05300 U05300	Reception was rejected by the recipient because communication requirements are not met due to the reception restriction set on the recipient machine. Check with the recipient.
E14000 U14000	Reception to the Sub Address Box was stopped because there is no more free space in the memory of this machine. Create free space by outputting the data stored in the memory, or cancel the reception to the Sub Address Box.
E14100 U14100	Transmission to the Sub Address Box or sub address box on our-brand recipient machine was stopped because there is no more free space in the memory of the recipient machine. Check with the recipient.
E19000 U19000	Memory reception was stopped because there is no more free space in the memory of this machine. Create free space by outputting the data stored in the memory, and ask the sender to resend.
E19100 U19100	Transmission was stopped because there is no more free space in the memory of the recipient machine. Check with the recipient.
E19300 U19300	Transmission was stopped due to a data error occurring during transmission. Send again.
1101	Failed to send i-FAX. Check the host name of the SMTP server on the Command Center RX.
1102	Failed to send i-FAX. Check the following on the Command Center RX. <ul style="list-style-type: none"> <li>• SMTP login user name and login password</li> <li>• POP3 login user name and login password</li> </ul>
1104	Failed to send i-FAX. Check the i-FAX address.   <b>NOTE</b> If the address is rejected by the domain, you cannot send the E-mail.
1105	Failed to send i-FAX. Select <b>[On]</b> of the i-FAX settings on the Command Center RX.
1106	Failed to send i-FAX. Check the sender address of SMTP on the Command Center RX.

Error Code	Possible Cause/Action
2101	Failed to send i-FAX. Check the network and Command Center RX. <ul style="list-style-type: none"> <li>• The network cable is connected.</li> <li>• The hub is not operating properly.</li> <li>• The server is not operating properly.</li> <li>• POP3 server name of the POP3 user</li> <li>• SMTP server name</li> </ul>
2102 2103	Failed to send i-FAX. Check the network and SMB settings. <ul style="list-style-type: none"> <li>• The network cable is connected.</li> <li>• The hub is not operating properly.</li> <li>• The server is not operating properly.</li> </ul>
2204	Failed to send i-FAX. Check the e-mail size limit of the SMTP server on the Command Center RX.
3101	Failed to send i-FAX. Check the authentication methods of both the sender and the recipient.
3201	Failed to send i-FAX. Check the authentication methods of both the sender and the recipient.

# Troubleshooting

When a problem occurs, first check the following. If the problem persists, contact your dealer or service representative.

Symptom	Checkpoint	Corrective Action	Reference Page
<b>Cannot send document.</b>	Is the modular cord connected correctly?	Connect the modular cord correctly.	—
	Is <i>Send error</i> displayed?	Remedy the cause of error and send again.	<a href="#">11-6</a>
	Is TX (transmission) restriction activated?	Cancel the TX restriction.	<a href="#">8-16</a>
	Are you using an IP telephone line?	You may be able to temporarily clear the communication error by changing the setting of [ <b>TX Start Speed</b> ] in Transmission.	<a href="#">8-11</a>
<b>Cannot perform encrypted communication.</b>	Are the registrations correct both at sender and recipient?	Double-check the registrations both at sender and recipient.	<a href="#">5-36</a>
<b>Cannot use the remote switching function.</b>	Is a pulse line used?	Some phones may transmit tone signals using buttons. Refer to the operation manual of your phone set.	—
	Is the remote switching number correct?	Check the registration. (Default: 55)	<a href="#">8-13</a>
	Did you press the remote switching number too quickly?	Press the remote switching number twice slowly.	—
<b>No print output after reception.</b>	Is memory forwarding activated?	Check the forwarding destination.	<a href="#">5-2</a>
<b>Cannot receive document.</b>	Is the modular cord connected correctly?	Connect the modular cord correctly.	—
	Is <i>Communication error</i> displayed?	Remedy the cause of error and ask the sender to retry.	<a href="#">11-6</a>
	Are you using an IP telephone line?	You may be able to temporarily clear the communication error by changing the setting of [ <b>RX Start Speed</b> ] in Reception.	<a href="#">8-13</a>
	Is RX (reception) restriction activated?	Cancel the RX restriction.	<a href="#">8-16</a>
<b>Cannot receive 2 in 1 reception.</b>	Are 2 in 1 reception and duplex reception both set?	Cancel the duplex printing.	<a href="#">4-8</a>
<b>Cannot perform memory reception.</b>	Is free space available in the memory?	Receive after free space has been created in the memory, or create free space in the memory by printing or deleting, etc., the source document in the FAX Box.	—

Symptom	Checkpoint	Corrective Action	Reference Page
<b>Cannot perform sub address transmission.</b>	Is the recipient fax machine equipped with a sub address transmission feature?	Sub address transmission cannot be performed unless the recipient fax machine has a similar sub address transmission feature.	—
	Is the entered sub address or sub address password identical to the sub address or sub address password registered in the recipient fax machine?	If your entry is correct, check with the recipient. This machine does not use a sub address password for reception.	<a href="#">5-25</a>
	Is free space available in the memory of the recipient fax machine?	Check with the recipient.	—
<b>Cannot perform memory forwarding.</b>	Is memory forwarding set to [On]?	Check the memory forwarding setting.	<a href="#">5-2</a>
<b>Cannot perform memory forwarding using a sub address.</b>	Is the recipient fax machine equipped with a sub address transmission feature?	Sub address transmission cannot be performed unless the recipient fax machine has a similar sub address transmission feature.	—
	Is the entered sub address identical to the sub address registered in the recipient fax machine?	If your entry is correct, check with the recipient. This machine does not use a sub address password for reception.	<a href="#">5-2</a>
<b>Cannot store memory forwarding data in a FAX Box.</b>	Is the FAX Box specified correctly?	Check the memory forwarding setting.	<a href="#">5-4</a>
	Is free space available in the memory?	Receive after free space has been created in the memory, or create free space in the memory by printing or deleting, etc., the source document in the FAX Box.	—
<b>Cannot output from a FAX Box.</b>	Is the box password been set?	Enter the correct box password.	<a href="#">5-17</a>
<b>Cannot use polling reception.</b>	Is polling transmission being used correctly on the sending machine?	Check with the sending machine.	—
<b>Cannot use sub address relay broadcast communication.</b>	Is free space available in the memory?	Send after free space has been created in the memory, or create free space in the memory by printing or deleting, etc., the source document in the FAX Box.	—



Symptom	Checkpoint	Corrective Action	Reference Page
<b>Cannot use sub address bulletin board communication.</b>	Does the other party's fax machine have the same sort of sub address bulletin board communication function?	If the other party's fax machine does not have the same sort of sub address bulletin board communication function, it cannot receive faxes via a sub address bulletin board. Check with the recipient.	—
	Is the entered sub address or sub address password correct?	If your entry is correct, check with the recipient.	—

## Common inquiries

The following are the inquiries that are frequently received after this product has been purchased.

	Question	Answer
1	I want to add a completion stamp when sending faxes.	This product does not have a function for completion stamps.
2	I want to send and receive faxes in color.	Fax images are transmitted and received in black and white.

# 12 Appendix

This chapter explains the following topics:

- Character Entry Method ..... 12-2
  - Entry Screens ..... 12-2
  - Entering Characters ..... 12-4
- Specifications ..... 12-5
- Menu Map ..... 12-7
- Received FAX Sizes and Paper Priority (Metric Model) ..... 12-13
- Received FAX Sizes and Paper Priority (Inch Model) ..... 12-17

# Character Entry Method

To enter characters for a name, use the on-display keyboard in the touch panel following the steps as explained below.

## NOTE

### Keyboard Layout

"QWERTY", "QWERTZ" and "AZERTY" are available as keyboard layouts the same as a PC keyboard. Select the [System Menu/Counter] key, [Common Settings] and then [Keyboard Layout] to choose the desired layout. "QWERTY" layout is used here as an example. You may use another layout following the same steps.

## Entry Screens

### Lower-case Letter Entry Screen

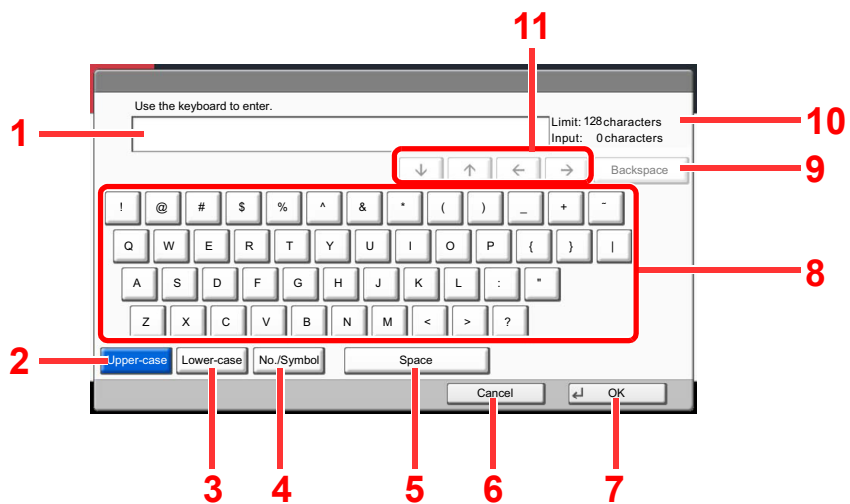

No.	Display/Key	Description
1	Display	Displays entered characters.
2	[Upper-case]	Select to use upper-case letters.
3	[Lower-case]	Select to use lower-case letters.
4	[No./Symbol]	Select to enter numbers and symbols.
5	[Space]	Select to insert a space.
6	[Cancel]	Select to cancel entered characters and return to the screen before the entry.
7	[OK]	Select to finalize entry and return to the screen before the entry.
8	Keyboard	Select a character to enter.
9	[Backspace]	Select to delete a character to the left of the cursor.
10	Limit Display	Displays maximum number of characters.
11	Cursor Key	Select to move the cursor on the display.

## Upper-case Letter Entry Screen

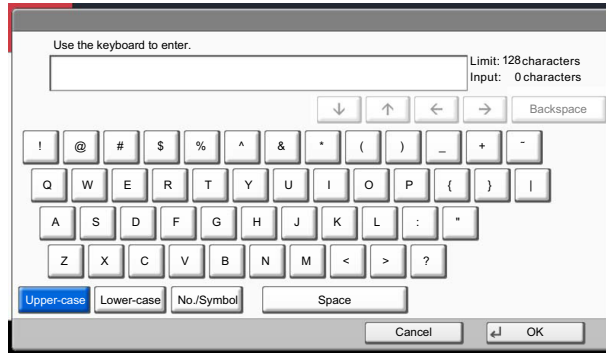

## Number/Symbol Entry Screen

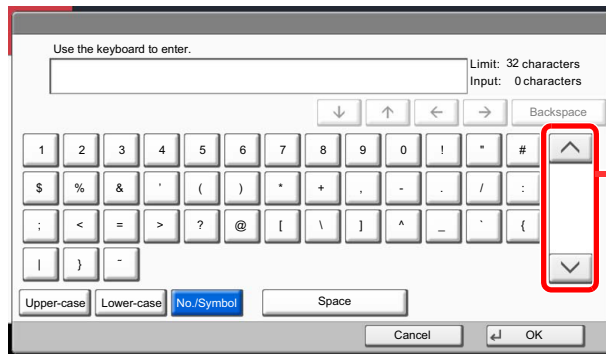

No.	Display/Key	Description
12	[^]/[v]	To enter a number or symbol not shown in the keyboard, select the cursor key and scroll the screen to view other numbers or symbols to enter.

## Entering Characters

Follow the steps below to enter 'List A-1' for an example.

- 1 Select [Upper-case].
- 2 Select [L]. The letter "L" is shown on the display.

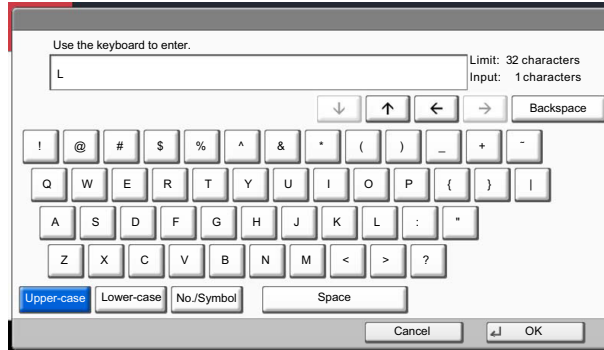

- 3 Select [Lower-case].
- 4 Select [i], [s], [t] and [Space].

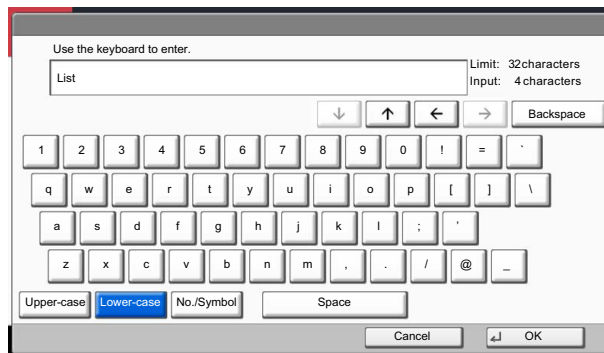

- 5 Select [Upper-case].
- 6 Select [A].
- 7 Select [No./Symbol].
- 8 Select [^] or [v] repeatedly to view the keyboard containing [-] and [1].
- 9 Select [-] and [1].

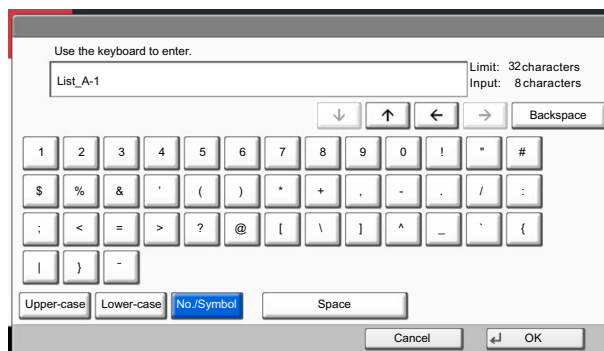

- 10 Check that the entry is correct. Press [OK].

# Specifications

**IMPORTANT**

Specifications are subject to change without notice.

**FAX function**

Item	Description
Compatibility	G3
Communication Line	Subscriber telephone line
Transmission Time	Less than 3 seconds (33600 bps, JBIG, ITU-T A4-R #1 chart)
Transmission Speed	33600/31200/28800/26400/24000/21600/19200/16800/14400/ 12000/9600/7200/4800/2400 bps
Coding Scheme	JBIG/MMR/MR/MH
Error Correction	ECM
Original Size	Max. width: 11"/297 mm, Max. length: 63"/1,600 mm
Automatic Document Feed	Max. 270 sheets (with document processor)
Resolution	Scan: 200 × 100 dpi Normal (8 dot/mm × 3.85 line/mm) 200 × 200 dpi Fine (8 dot/mm × 7.7 line/mm) 200 × 400 dpi Super (Super Fine) (8 dot/mm × 15.4 line/mm) 400 × 400 dpi Ultra (Ultra Fine) (16 dot/mm × 15.4 line/mm) 600 × 600 dpi Print: 600×600 dpi
Gradations	256 shades (Error diffusion)
One Touch Key	1,000 keys
Multi-Station Transmission	Max. 500 destinations (Maximum number of stations: 500, maximum of 100 stations for i-Fax)
Substitute Memory Reception	7,000 sheets or more (when using ITU-T A4 #1)
Image Memory Capacity	170 MB
Report Output	Send result report, FAX RX result report, Activity report, Status page
Option	Dual Port, Internet FAX Kit

**Network FAX functions**

Item	Description
Hardware	IBM PC-AT compatible computer
Interface	10BASE-T, 100BASE-TX, 1000BASE-T, 802.3a supported
Operating system	Windows 7, Windows 8.1 and Windows 10, Windows Server 2008/R2, Windows Server 2012/R2, Windows Server 2016, Windows Server 2019
Transmission Resolution	Ultra fine (400 × 400dpi), Fine (200 × 200dpi), Normal (100 × 200dpi), 600 × 600dpi
Document Size	Letter, Legal, Ledger (11 x 17), Statement, A3, A4,A5, Folio, B4, B5(JIS)
FAX Delayed Transmit	Based on settings in the Network FAX Driver (setting is possible to any 1 minute increment within the subsequent 24 hour period)
Transmit and Print	Fax transmission and print out at the machine is available
Broadcast Transmission	Max. 500 destinations (Maximum number of stations: 500, maximum of 100 stations for i-Fax)
Job Accounting	Requires the input of a Login User Name and Password in the Network FAX Driver when User Login, is turn ON in the fax machine. Requires the input of an Account ID in the Network FAX Driver when Job Accounting, is turned ON in the fax machine.
Cover Page	A format can be selected using the Network FAX Driver or a template can be created.



# Menu Map



Destination (page 3-7)	Address Book (page 3-9)	
	Check Destinations (page 7-13)	
	On Hook (page 3-31)	
	Direct (page 3-29)	
	Chain (page 3-34)	
	Detail (page 3-7)	Sub Address (page 3-7)
		Transmission Start Speed (page 3-7)
		ECM (page 3-7)
		Encrypted Transmission (page 3-7)
	Dest. History (page 3-12)	
	Recall (page 3-3)	
One-Touch Key (page 3-11)		
Quick Setup (page 2-28)		
Org./Sending Data Format	Original Size (page 3-21)	
	Mixed Sized Original (page 3-21) <sup>*1</sup>	
	2-side/Book Original (page 3-22) <sup>*2</sup>	
	Original Orientation (page 3-22)	
	Sending Size (page 3-23)	
	Long Original (page 3-23) <sup>*1</sup>	
Image Quality	Density (page 3-23)	
	Original Image (page 3-23)	
	FAX TX Resolution (page 3-24)	
Advanced Setup	Zoom (page 3-24)	
	Centering (page 3-24)	
	Border Erase/Full Scan (page 3-25)	
	FAX Delayed Transmission (page 3-26)	
	Continuous Scan (page 3-28)	
	Job Finish Notice (page 3-28)	
	File Name Entry (page 3-29)	
	FAX Direct Transmission (page 3-29)	
	FAX Polling RX (page 5-31)	
	Send and Print (page 3-30)	
	Send and Store (page 3-30)	
FAX TX Report (page 3-30)		
Program (page 3-36)		

\*1 This is displayed if the document processor is optional, and has been installed.

\*2 The display reads "Book original" if the document processor is optional, and has not been installed.

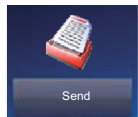

Destination	i-FAX Address Entry (page 10-10)* <sup>1</sup>
	FAX Server (refer to the machine's <i>Operation Guide</i> )

\*1 Optional Internet FAX Kit is required.



FAX Box (page 5-17)
---------------------

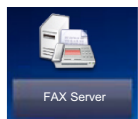

FAX Server (refer to the machine's <i>Operation Guide</i> )
---



FAX Memory RX Box (page 5-35)
-------------------------------

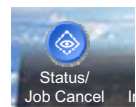
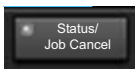

Printing Jobs (page 7-3)	Status (refer to the machine's <i>Operation Guide</i> )
	Log (page 7-3)
Sending Jobs (page 7-3)	Status (refer to the machine's <i>Operation Guide</i> )
	Scheduled Job (page 3-28)
	Log (page 7-3)
Storing Jobs (page 7-3)	Status (refer to the machine's <i>Operation Guide</i> )
	Log (page 7-3)
Device/Communicate	Scanner (refer to the machine's <i>Operation Guide</i> )
	Printer (refer to the machine's <i>Operation Guide</i> )
	Line Off (page 3-6)
	Manual RX (page 4-4)
	Check New FAX (i-FAX Reception) (page 10-13)* <sup>1</sup>
	Log (page 7-10)
	USB Drive (refer to the machine's <i>Operation Guide</i> )
Connectivity (refer to the machine's <i>Operation Guide</i> )	
Paper/Supplies (refer to the machine's <i>Operation Guide</i> )	

\*1 Optional Internet FAX Kit is required.

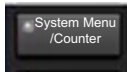

Quick Setup Wizard	FAX Setup (page 2-12)		
	E-mail Setup (refer to the machine's <i>Operation Guide</i> )		
	Network Setup (refer to the machine's <i>Operation Guide</i> )		
	Energy Saver Setup (refer to the machine's <i>Operation Guide</i> )		
Counter (refer to the machine's <i>Operation Guide</i> )			
Cassette/MP Tray Settings	Cassette 1 (to 7) <sup>*1</sup> (page 8-5)		
	MP Tray Setting (page 8-6)		
Common Settings	Language (refer to the machine's <i>Operation Guide</i> )		
	Default Screen (refer to the machine's <i>Operation Guide</i> )		
	Sound (page 8-6)	Buzzer (refer to the machine's <i>Operation Guide</i> )	
		FAX Speaker Volume (page 8-6)	
		FAX Monitor Volume (page 8-6)	
	Keyboard Layout (refer to the machine's <i>Operation Guide</i> )		
	Original/Paper Settings (refer to the machine's <i>Operation Guide</i> )		
	Measurement (refer to the machine's <i>Operation Guide</i> )		
	Error Handling (refer to the machine's <i>Operation Guide</i> )		
	Paper Output (page 8-7) <sup>*2</sup>	FAX Port 1 (page 8-7)	
		FAX Port 2 <sup>*3</sup> (page 8-7)	
	Orientation Confirmation (refer to the machine's <i>Operation Guide</i> )		
	Color Toner Empty Action (refer to the machine's <i>Operation Guide</i> ) <sup>*4</sup>		
	Function Defaults (page 8-8)	FAX TX Resolution (page 8-8)	
		i-FAX Subject/Body <sup>*5</sup> (page 8-8)	
		Continuous Scan (FAX) (page 8-8)	
	Optional Keyboard Type (refer to the machine's <i>Operation Guide</i> )		
	System Stamp (refer to the machine's <i>Operation Guide</i> )		
	Manual Staple (refer to the machine's <i>Operation Guide</i> )		
	Offset Documents by Job (refer to the machine's <i>Operation Guide</i> )		
	Low Toner Alert (refer to the machine's <i>Operation Guide</i> )		
	Toner Waste Full Alert (refer to the machine's <i>Operation Guide</i> ) <sup>*6</sup>		
	Offset One Page Documents (refer to the machine's <i>Operation Guide</i> )		
	Display Status/Log (page 8-8)	Display FAX Log (page 8-8)	
	Message Banner Print (refer to the machine's <i>Operation Guide</i> )		
	Customize Status Display (refer to the machine's <i>Operation Guide</i> )		
	Message Board Settings (refer to the machine's <i>Operation Guide</i> )		

Common Settings	Remote Printing (refer to the machine's <i>Operation Guide</i> )			
	Numeric Keypad Settings (refer to the machine's <i>Operation Guide</i> )			
	Prevent Light Reflection (refer to the machine's <i>Operation Guide</i> )			
	Function Key Assignment (refer to the machine's <i>Operation Guide</i> )			
	Show Power Off Message (page 8-8)			
	Clear Set. after Job Started (refer to the machine's <i>Operation Guide</i> )			
	Direct Printing from Web (refer to the machine's <i>Operation Guide</i> )			
Home (refer to the machine's <i>Operation Guide</i> )				
Copy (refer to the machine's <i>Operation Guide</i> )				
Send (refer to the machine's <i>Operation Guide</i> )				
Document Box/ USB Drive	Custom Box (refer to the machine's <i>Operation Guide</i> )			
	FAX Box (page 5-17)			
	Job Box (refer to the machine's <i>Operation Guide</i> )			
	Polling Box (page 5-28)			
	FAX Memory RX Box (page 5-35)			
	Quick Setup Registration (page 2-28)			
FAX	TX/RX Common (page 8-9)	Encrypt. Key Registration (page 8-9)		
		FAX Remote Diagnosis (page 8-9)		
	Transmission (page 8-10)	Basic (page 8-10)	Local FAX Name (Port 1) (page 8-10)	
			Local FAX Name (Port 2) <sup>*3</sup> (page 8-10)	
			TTI (page 8-10)	
			Account as Local FAX Name (page 8-10)	
			Retry Times (page 8-10)	
			FAX (page 8-11)	Local FAX Number 1 (page 8-11)
		Local FAX Number 2 <sup>*3</sup> (page 8-11)		
		Dialing Mode (Port 1) (page 8-11)		
		Dialing Mode (Port 2) <sup>*3</sup> (page 8-11)		
		Local FAX ID (page 8-11)		
		ECM TX (Port 1) (page 8-11)		
		ECM TX (Port 2) <sup>*3</sup> (page 8-11)		
		TX Start Speed (Port 1) (page 8-11)		
		TX Start Speed (Port 2) <sup>*3</sup> (page 8-11)		
		Always Cont Scan w/Platen (page 8-11)		

FAX	Reception (page 8-12)	Basic (page 8-12)	Media Type (page 8-12)
			FAX Exclusive Paper Source (page 8-12)
			Multipurpose Tray (page 8-12)
			Reduced RX Size (page 8-12)
			Reception Date/Time (page 8-12)
			Duplex Printing (page 8-12)
			2 in 1 Printing (page 8-12)
	FAX (page 8-13)		Rings (Normal) (page 8-13)
			Rings (TAD) (page 8-13)
			Rings (FAX/TEL) (page 8-13)
			RX Setting (page 8-13)
			Remote SW Dial (page 8-13)
			Reception Port <sup>*3</sup> (page 8-13)
			ECM RX (Port 1) (page 8-13)
			ECM RX (Port 2) <sup>*3</sup> (page 8-13)
			RX Start Speed (Port 1) (page 8-13)
			RX Start Speed (Port 2) <sup>*3</sup> (page 8-13)
			Encryption Reception (page 8-14)
			TX/RX Restriction (page 8-16)
			RX/Forward Rules (page 5-2)
New Destination Entry (FAX) (page 8-14)			
			Quick Setup Registration (page 2-28)
Printer (refer to the machine's <i>Operation Guide</i> )			

Report	Report Print (page 8-15)	Status Page (page 8-15)
		Font List (refer to the machine's <i>Operation Guide</i> )
		Network Status (refer to the machine's <i>Operation Guide</i> )
		Service Status (refer to the machine's <i>Operation Guide</i> )
		Optional Network Status (refer to the machine's <i>Operation Guide</i> )
		Configuration List (refer to the machine's <i>Operation Guide</i> )
		Data Sanitization Report (refer to the machine's <i>Operation Guide</i> )
	Admin Report Settings (page 8-15)	Outgoing FAX Report (page 8-15)
		Incoming FAX Report (page 8-15)
	Result Report Setting (page 8-15)	Send Result Report (page 8-15)
		FAX RX Result Report (page 8-15)
		Job Finish Notice Setting (page 8-15)
		RX Result Report Type (page 8-15)
	Sending Log History (refer to the machine's <i>Operation Guide</i> )	
Login History Settings (refer to the machine's <i>Operation Guide</i> )		
Device Log History Settings (refer to the machine's <i>Operation Guide</i> )		
Secure Comm. Error Log (refer to the machine's <i>Operation Guide</i> )		
System/Network (refer to the machine's <i>Operation Guide</i> )		
Edit Destination	Address Book (page 2-16)	
	One Touch Key (page 2-25)	
	Print List (page 2-24)	
	Address Book Defaults	Sort (refer to the machine's <i>Operation Guide</i> )
		Narrow Down (refer to the machine's <i>Operation Guide</i> )
		Address Book Type (refer to the machine's <i>Operation Guide</i> )
	Edit Restriction	Address Book (refer to the machine's <i>Operation Guide</i> )
		One Touch Key (refer to the machine's <i>Operation Guide</i> )
User Login/Job Accounting (refer to the machine's <i>Operation Guide</i> )		
User Property (refer to the machine's <i>Operation Guide</i> )		
Date/Timer/Energy Saver (refer to the machine's <i>Operation Guide</i> )		
Adjustment/Maintenance (refer to the machine's <i>Operation Guide</i> )		
Internet (refer to the machine's <i>Operation Guide</i> )		
Application (refer to the machine's <i>Operation Guide</i> )		

\*1 The cassette tray displayed varies depending on the installation status of the optional paper feeder.

\*2 When an Inner Finisher and a 1,000-Sheet Finisher are installed with the machine, this function is not displayed.  
(When using TASKalfa 6053ci/TASKalfa 5053ci/TASKalfa 4053ci/TASKalfa 3553ci/TASKalfa 3253ci/  
TASKalfa 2553ci/TASKalfa 6003i/TASKalfa 5003i.)

\*3 This function is displayed when 2 optional FAX Kits (Dual FAX option) are installed.

\*4 This function is not displayed for TASKalfa 9003i/TASKalfa 8003i/TASKalfa 7003i/TASKalfa 6003i/TASKalfa 5003i.

\*5 Optional Internet FAX Kit is required.

\*6 This function is not displayed for TASKalfa 8353ci/TASKalfa 7353ci/TASKalfa 9003i/TASKalfa 8003i/TASKalfa 7003i.

# Received FAX Sizes and Paper Priority (Metric Model)

When no paper loaded in the cassettes matches the received fax size and orientation, the machine automatically chooses the printing paper according to the following priority.

## Same Size Override

If [Off] is set for Reduced RX Size, the printing paper is chosen by prioritizing the same size override.

➔ [Reduced RX Size \(page 4-7\)](#)

		Received FAX Size										
Priority	Paper Size											
	A5	B5	A4-R	A4	Folio	B4	A3	A4 Long Originals <sup>*1</sup>	Folio Long Originals <sup>*2</sup>	B4 Long Originals <sup>*3</sup>	A3 Long Originals <sup>*4</sup>	
1	A5	B5	A4-R	A4	Folio	B4	A3	A3	A3	A3	A3	A3
2	A5-R <sup>*5</sup>	B5-R <sup>*5</sup>	A4 <sup>*5</sup>	A4-R <sup>*5</sup>	A4-R	A3	A4	A3	A3	A3	A3	A4
3	A4-R	B4	Folio	Folio <sup>*5</sup>	A4 <sup>*5</sup>	B5	A4-R <sup>*5</sup>	B4	B4	B4	B4	A4-R <sup>*5</sup>
4	Folio	A4	A3	A3	A3	B5-R <sup>*5</sup>	Folio <sup>*5</sup>	B4	B4	B5	Folio <sup>*5</sup>	
5	A4 <sup>*5</sup>	A4-R <sup>*5</sup>	B4	B4 <sup>*5</sup>	B4	A4, <sup>*7</sup>	B4 <sup>*5,*7</sup>	A4-R	Folio	B5-R <sup>*5</sup>	B4 <sup>*5</sup>	
6	B5	Folio <sup>*5</sup>	A5		A4-R	A4	B4 <sup>*5</sup>	A4 <sup>*5</sup>	A4-R <sup>*6</sup>	A4		
7	B5-R <sup>*5</sup>	A3	A5-R <sup>*5</sup>		A4 <sup>*5</sup>	A4-R <sup>*5,*7</sup>		A5	A4-R	A4-R <sup>*5</sup>		
8	A3		B5 <sup>*7</sup>		A5	A4-R <sup>*5</sup>		A5-R <sup>*5</sup>	A4 <sup>*5,*6</sup>	Folio <sup>*5</sup>		
9	B4		B5		A5-R <sup>*5</sup>	Folio <sup>*5,*7</sup>		B5	A4 <sup>*5</sup>			
10			B5-R <sup>*5,*7</sup>		B5	Folio <sup>*5</sup>		B5-R <sup>*5</sup>	A5			
11			B5-R <sup>*5</sup>		B5-R <sup>*5</sup>				A5-R <sup>*5</sup>			
12									B5			
13									B5-R <sup>*5</sup>			

- \*1 A4 Long Originals: Originals longer than A4 in the direction of the paper feed.
  - \*2 Folio Long Originals: Originals longer than Folio in the direction of the paper feed.
  - \*3 B4 Long Originals: Originals longer than B4 in the direction of the paper feed.
  - \*4 A3 Long Originals: Originals longer than A3 in the direction of the paper feed.
  - \*5 Paper orientation is different from the received document. The image is printed after being rotated 90° automatically.
  - \*6 The document is printed on this paper when the length of the document received is 351 to 380.4 mm and the cassette set as the Folio size is empty.
  - \*7 The document is printed on this paper when the length of the document received is short.
-  indicates print output on two sheets.

 **NOTE**

When a paper type is selected in [**Media Type**], a received fax is printed using the matching paper source.

➔ [Media Type for Print Output \(page 4-6\)](#)















































































































Even if [**Media Type**] is selected, a received fax cannot be printed when the paper type loaded in the paper source is not suitable for fax printouts.



**Reduced RX Sizes**

If [On] is set for Reduced RX Size, the printing paper is chosen by prioritizing to reduce the paper size and print data on single paper.

➔ [Reduced RX Size \(page 4-7\)](#)

		Received FAX Size											
Priority		A5	B5	A4-R	A4	Folio	B4	A3	A4 Long Originals <sup>*1</sup>	Folio Long Originals <sup>*2</sup>	B4 Long Originals <sup>*3</sup>	A3 Long Originals <sup>*4</sup>	
													
Paper Size	1	A5 	B5 	A4-R 	A4 	Folio 	B4 	A3 	A3 	A3 	A3 	A3 	
	2	A5-R <sup>*5</sup> 	B5-R <sup>*5</sup> 	A4 <sup>*5</sup> 	A4-R <sup>*5</sup> 	A4-R 	A3 	B4 <sup>*6</sup> 	A3 	A3 	A3 	A4 	
	3	A4-R 	B4 	Folio 	Folio <sup>*5</sup> 	A4 <sup>*5</sup> 	A4-R <sup>*6</sup> 	A4-R <sup>*6</sup> 	B4 	B4 	B4 	B4 	A4-R <sup>*5</sup> 
	4	Folio 	A4 	A3 	A3 	A3 	A4 <sup>*5,*6</sup> 	A4 <sup>*5,*6</sup> 	B4 	B4 	B4 	B5 	Folio <sup>*5</sup> 
	5	A4 <sup>*5</sup> 	A4-R <sup>*5</sup> 	B4 	B4 <sup>*5</sup> 	B4 	Folio <sup>*6</sup> 	Folio <sup>*6</sup> 	A4-R 	Folio 	Folio 	B5-R <sup>*5</sup> 	B4 <sup>*5</sup> 
	6	B5 	Folio <sup>*5</sup> 	B5-R <sup>*6</sup> 	B5 <sup>*6</sup> 	B5-R <sup>*6</sup> 	B5-R <sup>*6</sup> 	B5-R <sup>*6</sup> 	A4 <sup>*5</sup> 	A4-R <sup>*7</sup> 	A4 	A4 	
	7	B5-R <sup>*5</sup> 	A3 	B5 <sup>*5,*6</sup> 	B5-R <sup>*5,*6</sup> 	B5 <sup>*5,*6</sup> 	B5 <sup>*5,*6</sup> 	B5 <sup>*5,*6</sup> 	A5 	A4-R 	A4-R <sup>*5</sup> 	A4-R <sup>*5</sup> 	
	8	A3 		A5-R <sup>*6</sup> 	A5 <sup>*6</sup> 	A5 			A5-R <sup>*5</sup> 	A4 <sup>*5,*6</sup> 	Folio <sup>*5</sup> 	Folio <sup>*5</sup> 	
	9	B4 		A5 <sup>*5,*6</sup> 	A5-R <sup>*5,*6</sup> 	A5-R <sup>*5</sup> 			B5 	A4 <sup>*5</sup> 			
	10								B5-R <sup>*5</sup> 	A5 			
	11									A5-R <sup>*5</sup> 			
	12									B5 			
	13									B5-R <sup>*5</sup> 			

- \*1 A4 Long Originals: Originals longer than A4 in the direction of the paper feed.
- \*2 Folio Long Originals: Originals longer than Folio in the direction of the paper feed.
- \*3 B4 Long Originals: Originals longer than B4 in the direction of the paper feed.
- \*4 A3 Long Originals: Originals longer than A3 in the direction of the paper feed.
- \*5 Paper orientation is different from the received document. The image is printed after being rotated 90° automatically.
- \*6 The data received is reduced to fit the paper size and then printed.
- \*7 The document is printed on this paper when the length of the document received is 351 to 380.4 mm and the cassette set as the Folio size is empty.

 indicates print output on two sheets.



#### NOTE

When a paper type is selected in [**Media Type**], a received fax is printed using the matching paper source.

➔ [Media Type for Print Output \(page 4-6\)](#)

Even if [**Media Type**] is selected, a received fax cannot be printed when the paper type loaded in the paper source is not suitable for fax printouts.



















































## Received FAX Sizes and Paper Priority (Inch Model)

When no paper loaded in the cassettes matches the received fax size and orientation, the machine automatically chooses the printing paper according to the following priority.

### Same Size Override

If [Off] is set for Reduced RX Size, the printing paper is chosen by prioritizing the same size override.

➔ [Reduced RX Size \(page 4-7\)](#)

		Received FAX Size							
Priority		Statement 	Letter 	Letter 	Legal 	Ledger 	Letter Long Originals <sup>*1</sup> 	Legal Long Originals <sup>*2</sup> 	Ledger Long Originals <sup>*3</sup> 
Paper Size	1	Statement <sup>*4</sup> 	Letter 	Letter 	Legal 	Ledger 	Ledger 	Legal 	Ledger 
	2	Letter 	Letter <sup>*4</sup> 	Letter <sup>*4</sup> 	Letter 	Letter 	Ledger 	Ledger 	Letter 
	3	Legal 	Legal 	Legal <sup>*4</sup> 	Letter <sup>*4</sup> 	Letter <sup>*4</sup> 	Letter 	Ledger 	Letter <sup>*4</sup> 
	4	Letter <sup>*4</sup> 	Ledger 	Ledger 	Ledger 	Legal <sup>*4</sup> 	Letter <sup>*4</sup> 	Letter <sup>*5</sup> 	Legal <sup>*4</sup> 
	5	Ledger 	Statement <sup>*4</sup> 		Letter 		Statement <sup>*4</sup> 	Letter 	
	6				Letter <sup>*4</sup> 			Letter <sup>*4, *5</sup> 	
	7				Statement <sup>*4</sup> 			Letter <sup>*4</sup> 	
	8							Statement <sup>*4</sup> 	

\*1 Letter Long Originals: Originals longer than Letter in the direction of the paper feed.

\*2 Legal Long Originals: Originals longer than Legal in the direction of the paper feed.

\*3 Ledger Long Originals: Originals longer than Ledger in the direction of the paper feed.

\*4 Paper orientation is different from the received document. The image is printed after being rotated 90° automatically.

\*5 The document is printed on this paper when the length of the document received is 376.6 to 379.3 mm and the cassette set as the Legal size is empty.

 indicates print output on two sheets.



### NOTE

When a paper type is selected in [Media Type], a received fax is printed using the matching paper source.

















































➔ [Media Type for Print Output \(page 4-6\)](#)

Even if [Media Type] is selected, a received fax cannot be printed when the paper type loaded in the paper source is not suitable for fax printouts.

**Reduced RX Sizes**

If [On] is set for Reduced RX Size, the printing paper is chosen by prioritizing to reduce the paper size and print data on single paper.

➔ [Reduced RX Size \(page 4-7\)](#)

		Received FAX Size							
Priority		Statement 	Letter 	Letter 	Legal 	Ledger 	Letter Long Originals <sup>*1</sup> 	Legal Long Originals <sup>*2</sup> 	Ledger Long Originals <sup>*3</sup> 
	Paper Size	1	Statement <sup>*4</sup> 	Letter 	Letter 	Legal 	Ledger 	Ledger 	Legal 
2		Letter 	Letter <sup>*4</sup> 	Letter <sup>*4</sup> 	Letter 	Letter <sup>*6</sup> 	Ledger 	Ledger 	Letter 
3		Legal 	Legal 	Legal <sup>*4</sup> 	Letter <sup>*4</sup> 	Letter <sup>*4, *6</sup> 	Letter 	Ledger 	Letter <sup>*4</sup> 
4		Letter <sup>*4</sup> 	Ledger 	Ledger 	Ledger 	Legal <sup>*6</sup> 	Letter <sup>*4</sup> 	Letter <sup>*5</sup> 	Legal <sup>*4</sup> 
5		Ledger 	Statement <sup>*6</sup> 	Statement <sup>*4, *6</sup> 	Statement <sup>*4</sup> 		Statement <sup>*4</sup> 	Letter 	
6								Letter <sup>*4, *5</sup> 	
7								Letter <sup>*4</sup> 	
8								Statement <sup>*4</sup> 	

\*1 Letter Long Originals: Originals longer than Letter in the direction of the paper feed.

\*2 Legal Long Originals: Originals longer than Legal in the direction of the paper feed.

\*3 Ledger Long Originals: Originals longer than Ledger in the direction of the paper feed.

\*4 Paper orientation is different from the received document. The image is printed after being rotated 90° automatically.

\*5 The document is printed on this paper when the length of the document received is 376.6 to 379.3 mm and the cassette set as the Legal size is empty.

\*6 The data received is reduced to fit the paper size and then printed.

 indicates print output on two sheets.

 **NOTE**

When a paper type is selected in [Media Type], a received fax is printed using the matching paper source.

➔ [Media Type for Print Output \(page 4-6\)](#)

Even if [Media Type] is selected, a received fax cannot be printed when the paper type loaded in the paper source is not suitable for fax printouts.

---

# Index

## Numerics

- 2 in 1 Print 4-8
- 2 in 1 Printing 8-12
- 2-sided/Book Original 3-22

## A

- Account as Local FAX Name 8-10
- Account Management 8-26
- Address Book 2-16, 3-9
  - Adding a contact 2-16
  - Adding a Group 2-21
  - Contact 2-16
  - Deleting 2-24
  - Editing 2-23
  - Printing Address List 2-24
  - Select a Destination 3-9

## B

- Batch Transmission Function 3-26
- Border Erase/Full Scan 3-25
- Broadcast Transmission 3-14

## C

- Cancel
  - Cancelling Delayed Transmission 3-28
  - Cancelling Direct Transmission 3-29
  - Cancelling Memory Forwarding 5-9
  - Cancelling Polling Transmissions 5-30
  - Cancelling Transmission (Disconnection of Communication) 3-6
- Canceling reception (Disconnection of communication) 4-3
- Cannot perform sub address transmission 11-11
- Cannot receive document 11-10
- Cannot send document 11-10
- Cannot use sub address relay broadcast communication 11-11
- Centering 3-24
- Chain Dial 3-34
- Character Entry Method 12-2
- Checking Transmission Results and Registration Status 7-2
- Common inquiries 11-13
- Confirmation Screen of Destinations 7-13
- Continuous Scan 3-28

## D

- Date 2-15
- Default
  - Continuous Scan (FAX) 8-8
  - FAX TX Resolution 8-8
  - i-FAX Subject/Body 8-8
- Default fax settings 8-2
- Delayed Transmission
  - Changing/Deleting 3-27
  - Immediate Transmission 3-28
- Density 3-23
- Destination
  - Search 3-10
- Destination History 3-12
- Direct SMTP 10-2
- Direct Transmission
  - Cancel 3-29
- Display Status/Log 8-8
- Document Processor 2-3
- DRD Reception 5-45
- Dual FAX 9-3
- Duplex Printing 4-8, 8-12

## E

- ECM RX 8-13
- ECM TX 8-11
- Edit Destination
  - Contact 2-16
- E-mail Notice
  - Job Finish Notice 3-28
  - Reporting FAX Receipt Result 7-12
- Encryption Communication 5-37
  - Changing Registration Contents of Encryption Key 5-38
  - Deleting Registration Contents of Encryption Key 5-39
  - Encryption Box No. 5-37
  - Encryption Key 5-38
  - Encryption Key No. 5-37
  - Registering an Encryption Key 5-38
  - Setting the Encrypted Reception 5-40
  - Using the Encrypted Transmission 5-39
- Encryption RX 8-14
- Enter key 2-11
- Error Code List 11-6

## F

- FAX/Answering Machine Auto Switch Reception [5-43](#)
- FAX/TEL Auto Switch Reception [5-41](#)
- FAX Automatic Reception [4-2](#), [8-13](#)
- FAX Box Function [5-17](#), [11-11](#)
  - Checking [5-22](#)
  - Deleting Originals after Printing from a FAX Box [5-23](#)
  - Deleting Originals from a FAX Box [5-23](#)
  - FAX Box List [5-24](#)
  - How to Change [5-20](#)
  - How to Delete [5-20](#)
  - How to Register [5-18](#)
  - Previews [5-22](#)
  - Printing Originals from FAX Box [5-21](#)
- FAX Delayed Transmission [3-26](#)
  - Immediate Transmission [3-28](#)
- FAX Direct Transmission [3-29](#)
  - Cancel [3-29](#)
- FAX Driver
  - Basic Transmission [6-7](#)
  - Flow of Receiving [6-2](#)
  - Flow of Sending [6-2](#)
  - Installing the FAX Driver [6-4](#)
  - Setup [6-3](#)
- FAX Exclusive Paper Source [4-7](#), [8-12](#)
- FAX Job History [7-3](#)
  - Details of the Job Log [7-5](#)
  - Job Log Screen [7-3](#)
  - Printing Job Log [7-4](#)
  - Sending Job Log [7-4](#)
  - Storing Job Log [7-5](#)
- FAX Media Type [4-6](#)
- FAX Memory RX Box [5-35](#)
- FAX Remote Diagnosis [8-9](#)
- FAX TX Report [3-30](#)
- FAX TX Resolution [3-24](#)
- File Name Entry [3-29](#)
- Forward Settings [5-4](#)
  - Command Center RX [5-16](#)
- Function Key Assignment [8-8](#)

## H

- Home Screen [2-6](#)

## I

- i-FAX Transmission [10-10](#)
- Indicators [11-2](#)
- Internet Faxing [10-1](#)
  - Command Center RX [10-5](#)
  - Notes on Using [10-3](#)
  - Reception [10-13](#)
- Internet FAX Kit [9-2](#)
- Interrupt Send [3-33](#)

## J

- Job Accounting [8-26](#)
  - Communication Form Subject to Job Accounting [8-27](#)
- Contents [8-26](#)
- Limit [8-27](#)
- Login [3-18](#)

## L

- Local FAX ID [2-12](#), [8-11](#)
- Local FAX Name [2-12](#), [8-10](#)
- Local FAX Number [2-12](#), [8-11](#)
- Long Original [3-23](#)

## M

- Machine (Names) [2-2](#)
- Manual Reception [4-4](#), [5-48](#)
- Manual Send [3-31](#), [5-47](#)
- Media Type for Print Output [4-6](#), [8-12](#)
- Memory Forwarding [5-2](#)
- Memory Reception [4-3](#)
- Memory Transmission [3-2](#)
- Menu Map [12-7](#)
- Messages [11-4](#)
- Methods For Entering the Destination [3-7](#)
- Mixed Size Originals [3-21](#)
- Multipurpose Tray [4-7](#), [8-12](#)

## N

- Network FAX
  - Basic Transmission [6-7](#)
  - Flow of Receiving [6-2](#)
  - Flow of Sending [6-2](#)
  - Installing the FAX Driver [6-4](#)
  - Setup [6-3](#)
- New Destination Entry(FAX) [8-14](#)
- No Print Output [11-10](#)

## O

- One Touch Key [2-25](#)
  - Editing and Deleting [2-26](#)
  - Printing One Touch Key List [2-27](#)
- Operation Panel [2-4](#)
- Original Image [3-23](#)
- Original Orientation [3-22](#)
- Original Size [3-21](#)

## P

- Paper Output [8-7](#)
- Part Names and Functions [2-2](#)
- Permit Fax No.
  - Change [8-18](#)
  - Change/Deletion [8-18](#)
  - Registration [8-17](#)
- Permit ID No.
  - Change [8-21](#)
  - Deletion [8-21](#)
  - Registration [8-20](#)
- Polling Communication [5-28](#)
  - Checking [5-34](#)
  - Deleting Originals in a Polling Box [5-34](#)
  - Polling Reception [5-31](#)
  - Polling Transmission [5-28](#)
  - Printing from a Polling Box [5-33](#)
  - Sub Address Bulletin Board
    - Communication [5-31](#)
- Precautions When Turning Power OFF [11-3](#)
- Previews
  - FAX Box [5-22](#)
- Printing/Sending Received Faxes by Requirements (Memory Forwarding)
  - Cancel [5-10](#)
  - Registering Settings by Requirement [5-6](#)
  - Requirements for Forwarding [5-2](#)
  - Type of Forwarding Destination [5-2](#)
  - Using Requirements for All Receptions [5-4](#)
- Priority Override Send [3-4](#)

## Q

- Quick No. Search key [2-11](#)
- Quick Setup Registration [8-14](#)
- Quick Setup Screen [2-28](#)
  - Changing Registration [2-29](#)
  - Functions Available for Registration [2-28](#)
- Quick Setup Wizard [2-12](#)

## R

- Received FAX Sizes and Paper Priority [12-13](#), [12-17](#)
- Receiving Mode [4-2](#)
- Reception Date/Time [4-8](#), [8-12](#)
- Reception Port [8-13](#)
- Redial [3-3](#)
  - Changing Retry Times [8-10](#)
- Reduced RX Size [4-7](#), [8-12](#)
- Reject Fax No.
  - Change [8-19](#)
  - Deletion [8-20](#)
  - Registration [8-19](#)
- Remote Switch Function [5-49](#), [8-13](#)
  - How to Register [8-13](#)
  - How to Use [5-49](#)
- Report
  - Activity Report [7-10](#)
  - Attach Image of NW FAX [7-8](#)
  - FAX Box List [5-24](#)
  - FAX RX Result Reports [7-9](#)
  - Printing a FAX Box List [5-24](#)
  - Report for Job Canceled
    - before Sending [7-8](#)
  - Send Result Reports [7-7](#)
- Rings
  - Answering Machine [8-13](#)
  - FAX/TEL [8-13](#)
  - Normal [8-13](#)
  - TAD [8-13](#)
- RX Date/Time [4-8](#)
- RX Setting [8-13](#)
- RX Start Speed [8-13](#)

## S

- Selection of Transmit

---

Terminal Identification (TTI) [2-12](#)  
Selection of Transmit Terminal Identification (TTI) [8-10](#)  
Send and Print [3-30](#)  
    Printing [3-30](#)  
    Storing [3-30](#)  
Send and Store [3-30](#)  
Sending Size [3-23](#)  
Send Status [3-4](#), [10-12](#)  
Shortcuts  
    Adding [2-30](#)  
    Editing and Deleting Shortcuts [2-31](#)  
Show Power Off Message [8-8](#)  
Sound  
    FAX Monitor Volume [8-6](#)  
    FAX Speaker Volume [8-6](#)  
    Job Finish [8-6](#)  
Sound Volume  
    FAX Monitor Volume [2-12](#)  
    FAX Speaker Volume [2-12](#)  
    Job Finish Buzzer [2-12](#)  
Specifications [12-5](#)  
Standby Transmission [3-32](#)  
Sub Address Bulletin Board Reception [5-31](#)  
Sub Address Communication [5-17](#)  
    Sub Address [5-18](#)  
    Sub Address Password [5-18](#)  
    Sub Address Transmission [5-25](#)  
Sub Address Relay Broadcast  
Communication [5-3](#), [5-27](#)  
Sub Address Relay Broadcast Communication [11-11](#)

## T

Telephone Line [2-12](#), [8-11](#)  
Time [2-15](#)  
Touch Panel [2-5](#)  
Transmission Restriction [8-16](#)  
    Communication Establishing Requirements [8-16](#)  
    Permit FAX No. [8-17](#)  
    Permit ID No. [8-20](#)  
    Prerequisites [8-16](#)  
    Reception Rejection Requirements [8-17](#)  
    Reception Restriction Setting [8-22](#)  
    Reject FAX No. [8-19](#)  
    Send Restriction Setting [8-22](#)  
    Unknown Number Reception [8-23](#)  
Troubleshooting [11-10](#)  
TX Start Speed [8-11](#)

## U

Unusable Time [8-24](#)  
User Accounting [8-26](#)  
    Contents [8-26](#)  
    Login [3-17](#)  
Using Program [3-36](#)

## Z

Zoom [3-24](#)



**QUALITY  
CERTIFICATE**

This machine has passed  
all quality controls and  
final inspection

